



PROJECT PRICE LIST 2025



Contents

—optipro—	MINIATURE CIRCUIT BREAKER (MCBs)	02 - 05
—optipro—	AC CIRCUIT BREAKER	06
—optipro—	DC CIRCUIT BREAKER	06 - 07
—optipro—	DC MCB WITH EXTENDED LINK AS PER RDSO	07
—optipro—	ISOLATOR	08
—optipro—	RESIDUAL CURRENT CIRCUIT BREAKER (RCCBs)	08
—optipro—	RCD ADD ON BLOCK	09
—optipro—	ACCESSORIES	09
NEW —optipro—	DISTRIBUTION BOARDS (DBs)	10 - 17
	BUSBAR CHAMBER	18
	TIME SWITCHES	19
	TIMELITE DISTRIBUTION BOARDS	20
	AUTOMATIC CHANGEOVER WITH CURRENT LIMITER (ACCL)	20
—optium—	MCCB - 1.0 (FIXED TM RANGE)	21 - 23
—optium—	MCCB - 1.1 (FIXED TM RANGE)	24
—optium—	MCCB - 2.0 (ADJUSTABLE TM RANGE)	24 - 26
—optium—	MCCB - 2.1 (ELECTRONIC RANGE)	26
—optium—	MCCB - 2.2 (ELECTRONIC RANGE WITH GROUND FAULT SETTING)	26 - 27
—optium—	MCCB - ACCESSORIES	27 - 29
—optipro—	SMDB	30 - 33
—optinova—	SWITCH DISCONNECTOR / TSE (ONLOAD CHANGEOVER)	34 - 35
	HRC FUSE LINKS & BASES	36
	SWITCH DISCONNECTOR FUSES	37
	Ambidex CHANGEOVER SWITCHES	38 - 39
	Shynora WIRING ACCESSORIES	40 - 51
	METAL & PLASTIC SURFACE BOX	50, 57, 64
	Glint [™] WIRING ACCESSORIES	52 - 58
	ELVIRA WIRING ACCESSORIES	59 - 65
NEW	Doorsta DING DONG DOORBELL	66, 68
	Zosta [™] EXHAUST FAN	67 - 68
	INDOASIAN PLUGS	68
	FANCY BATTEN BULB HOLDER / CEILING ROSE	68 - 69



— optipro[™] —

RCCB & MCB

ALL THAT YOU NEED

Engineered to perfection with wide range and unmatched quality.

Contact Indication Window-
Visual indication ensure
safety of end user

**Low Power
Loss**



—optipro— **MINIATURE CIRCUIT BREAKER - MCB**

- ISI / CE Marked as per IS/IEC 60898 - 1 • Rated Short-Circuit Breaking Capacity, Icn 10kA • Degree of Protection IP 20
- Energy Limitation Class 3 • Line Load Reversibility • 35 sq. mm Terminals • Biconnect Terminals • Frequency: 50 Hz
- Operating Voltage : 240V/415V AC , 60V DC per pole

B CURVE SINGLE POLE

HSN Code: 8536

	Rating (A)	Pack	Cat. Nos.	Unit Price (₹)
	6	1/12/180	811008	277
10	1/12/180	811010	277	
16	1/12/180	811012	277	
20	1/12/180	811013	277	
25	1/12/180	811014	277	
32	1/12/180	811015	277	
40	1/12/180	811016	638	
50	1/12/180	811017	743	
63	1/12/180	811018	743	

B CURVE SINGLE POLE NEUTRAL

HSN Code: 8536

	Rating (A)	Pack	Cat. Nos.	Unit Price (₹)
	6	1/6/90	811027	945
10	1/6/90	811029	945	
16	1/6/90	811031	945	
20	1/6/90	811032	945	
25	1/6/90	811033	945	
32	1/6/90	811034	945	
40	1/6/90	811035	1334	
50	1/6/90	811036	1513	
63	1/6/90	811037	1513	

B CURVE DOUBLE POLE

HSN Code: 8536

	Rating (A)	Pack	Cat. Nos.	Unit Price (₹)
	6	1/6/90	811046	981
10	1/6/90	811048	981	
16	1/6/90	811050	981	
20	1/6/90	811051	981	
25	1/6/90	811052	981	
32	1/6/90	811053	981	
40	1/6/90	811054	1428	
50	1/6/90	811055	1590	
63	1/6/90	811056	1590	

C CURVE SINGLE POLE

HSN Code: 8536

	Rating (A)	Pack	Cat. Nos.	Unit Price (₹)
	0.5	1/12/180	811114	500
1	1/12/180	811115	500	
2	1/12/180	811117	500	
3	1/12/180	811119	500	
4	1/12/180	811120	500	
5	1/12/180	811121	500	
6	1/12/180	811122	290	
10	1/12/180	811124	290	
16	1/12/180	811126	290	
20	1/12/180	811127	290	
25	1/12/180	811128	290	
32	1/12/180	811129	290	
40	1/12/180	811130	602	
50	1/12/180	811131	716	
63	1/12/180	811132	716	

—optipro™— **MINIATURE CIRCUIT BREAKER - MCB**

C CURVE SINGLE POLE NEUTRAL

HSN Code: 8536

	Rating (A)	Pack	Cat. Nos.	Unit Price (₹)
	0.5	1/6/90	811136	1046
	1	1/6/90	811137	1046
	2	1/6/90	811139	1046
	3	1/6/90	811141	1046
	4	1/6/90	811142	1046
	5	1/6/90	811143	1046
	6	1/6/90	811144	974
	10	1/6/90	811146	974
	16	1/6/90	811148	974
	20	1/6/90	811149	974
	25	1/6/90	811150	974
	32	1/6/90	811151	974
	40	1/6/90	811152	1388
	50	1/6/90	811153	1564
	63	1/6/90	811154	1564

C CURVE DOUBLE POLE

HSN Code: 8536

	Rating (A)	Pack	Cat. Nos.	Unit Price (₹)
	0.5	1/6/90	811158	1198
	1	1/6/90	811159	1198
	2	1/6/90	811161	1198
	3	1/6/90	811163	1198
	4	1/6/90	811164	1198
	5	1/6/90	811165	1198
	6	1/6/90	811166	1000
	10	1/6/90	811168	1000
	16	1/6/90	811170	1000
	20	1/6/90	811171	1000
	25	1/6/90	811172	1000
	32	1/6/90	811173	1000
	40	1/6/90	811174	1466
	50	1/6/90	811175	1644
	63	1/6/90	811176	1644

C CURVE THREE POLE

HSN Code: 8536

	Rating (A)	Pack	Cat. Nos.	Unit Price (₹)
	0.5	1/4/60	811180	1840
	1	1/4/60	811181	1840
	2	1/4/60	811183	1840
	3	1/4/60	811185	1840
	4	1/4/60	811186	1840
	5	1/4/60	811187	1840
	6	1/4/60	811188	1562
	10	1/4/60	811190	1562
	16	1/4/60	811192	1562
	20	1/4/60	811193	1562
	25	1/4/60	811194	1562
	32	1/4/60	811195	1562
	40	1/4/60	811196	2288
	50	1/4/60	811197	2418
	63	1/4/60	811198	2418

—optipro— **MINIATURE CIRCUIT BREAKER - MCB**

C CURVE THREE POLE NEUTRAL

HSN Code: 8536

	Rating (A)	Pack	Cat. Nos.	Unit Price (₹)
	0.5	1/3/45	811202	2362
1	1/3/45	811203	2362	
2	1/3/45	811205	2362	
3	1/3/45	811207	2362	
4	1/3/45	811208	2362	
5	1/3/45	811209	2362	
6	1/3/45	811210	2014	
10	1/3/45	811212	2014	
16	1/3/45	811214	2014	
20	1/3/45	811215	2014	
25	1/3/45	811216	2014	
32	1/3/45	811217	2014	
40	1/3/45	811218	2708	
50	1/3/45	811219	2866	
63	1/3/45	811220	2866	

C CURVE FOUR POLE

HSN Code: 8536

	Rating (A)	Pack	Cat. Nos.	Unit Price (₹)
	0.5	1/3/45	811224	2398
1	1/3/45	811225	2398	
2	1/3/45	811227	2398	
3	1/3/45	811229	2398	
4	1/3/45	811230	2398	
5	1/3/45	811231	2398	
6	1/3/45	811232	2230	
10	1/3/45	811234	2230	
16	1/3/45	811236	2230	
20	1/3/45	811237	2230	
25	1/3/45	811238	2230	
32	1/3/45	811239	2230	
40	1/3/45	811240	3056	
50	1/3/45	811241	3124	
63	1/3/45	811242	3124	

D CURVE SINGLE POLE

HSN Code: 8536

	Rating (A)	Pack	Cat. Nos.	Unit Price (₹)
	0.5	1/12/180	811246	512
1	1/12/180	811247	512	
2	1/12/180	811249	512	
3	1/12/180	811251	512	
4	1/12/180	811252	512	
5	1/12/180	811253	512	
6	1/12/180	811254	432	
10	1/12/180	811256	432	
16	1/12/180	811258	432	
20	1/12/180	811259	432	
25	1/12/180	811260	432	
32	1/12/180	811261	432	
40	1/12/180	811262	722	
50	1/12/180	811263	822	
63	1/12/180	811264	822	

—optipro™— **MINIATURE CIRCUIT BREAKER - MCB**

D CURVE DOUBLE POLE

HSN Code: 8536

	Rating (A)	Pack	Cat. Nos.	Unit Price (₹)
	0.5	1/6/90	811284	1352
	1	1/6/90	811285	1352
	2	1/6/90	811287	1352
	3	1/6/90	811289	1352
	4	1/6/90	811290	1352
	5	1/6/90	811291	1352
	6	1/6/90	811292	1044
	10	1/6/90	811294	1044
	16	1/6/90	811296	1044
	20	1/6/90	811297	1044
	25	1/6/90	811298	1044
	32	1/6/90	811299	1044
	40	1/6/90	811300	1496
	50	1/6/90	811301	1592
	63	1/6/90	811302	1592

D CURVE THREE POLE

HSN Code: 8536

	Rating (A)	Pack	Cat. Nos.	Unit Price (₹)
	0.5	1/4/60	811303	2004
	1	1/4/60	811304	2004
	2	1/4/60	811306	2004
	3	1/4/60	811308	2004
	4	1/4/60	811309	2004
	5	1/4/60	811310	2004
	6	1/4/60	811311	1588
	10	1/4/60	811313	1588
	16	1/4/60	811315	1588
	20	1/4/60	811316	1588
	25	1/4/60	811317	1588
	32	1/4/60	811318	1588
	40	1/4/60	811319	2418
	50	1/4/60	811320	2448
	63	1/4/60	811321	2448

D CURVE FOUR POLE

HSN Code: 8536

	Rating (A)	Pack	Cat. Nos.	Unit Price (₹)
	0.5	1/3/45	811341	2428
	1	1/3/45	811342	2428
	2	1/3/45	811344	2428
	3	1/3/45	811346	2428
	4	1/3/45	811347	2428
	5	1/3/45	811348	2428
	6	1/3/45	811349	2076
	10	1/3/45	811351	2076
	16	1/3/45	811353	2076
	20	1/3/45	811354	2076
	25	1/3/45	811355	2076
	32	1/3/45	811356	2076
	40	1/3/45	811357	2992
	50	1/3/45	811358	3098
	63	1/3/45	811359	3098

—optipro™— **AC CIRCUIT BREAKER**

- Conforms to IEC 60947-2 • CE Marked • Rated Short-Circuit Capacity, Icu 10kA • Degree of Protection IP 20
- 1.5 Module per pole • 50 sq. mm Terminals • Frequency: 50 Hz • Operating Voltage: 240V/415V AC, 60V DC per Pole

SINGLE POLE

HSN Code: 8536

	Rating (A)	Pack	Cat. Nos.	Unit Price (₹)
	80	1	811133	2578
	100	1	811134	2860
	125	1	811135	3184

DOUBLE POLE

HSN Code: 8536

	Rating (A)	Pack	Cat. Nos.	Unit Price (₹)
	80	1	811177	6020
	100	1	811178	6476
	125	1	811179	7098

THREE POLE

HSN Code: 8536

	Rating (A)	Pack	Cat. Nos.	Unit Price (₹)
	80	1	811199	8820
	100	1	811200	9504
	125	1	811201	10326

FOUR POLE

HSN Code: 8536

	Rating (A)	Pack	Cat. Nos.	Unit Price (₹)
	80	1	811243	11526
	100	1	811244	11902
	125	1	811245	13532

—optipro™— **DC CIRCUIT BREAKER**

- Conforms to IEC 60947-2 • CE Marked • Breaking Capacity 6kA • Degree of Protection IP 20 • 35 sq. mm Terminals
- Biconnect Terminals • Upto 250V Supply

SINGLE POLE

HSN Code: 8536

	Rating (A)	Pack	Cat. Nos.	Unit Price (₹)
	0.5	1/12/180	811400	648
	1	1/12/180	811401	648
	2	1/12/180	811403	648
	3	1/12/180	811405	648
	4	1/12/180	811406	648
	5	1/12/180	811407	648
	6	1/12/180	811408	582
	10	1/12/180	811410	582
	16	1/12/180	811412	582
	20	1/12/180	811413	582
	25	1/12/180	811414	582
	32	1/12/180	811415	582
	40	1/12/180	811416	772
	50	1/12/180	811417	796
	63	1/12/180	811418	796

—optipro™— DC CIRCUIT BREAKER

DOUBLE POLE

HSN Code: 8536

	Rating (A)	Pack	Cat. Nos.	Unit Price (₹)
		0.5	1/6/90	811419
1		1/6/90	811420	1470
2		1/6/90	811422	1470
3		1/6/90	811424	1470
4		1/6/90	811425	1470
5		1/6/90	811426	1470
6		1/6/90	811427	1206
10		1/6/90	811429	1206
16		1/6/90	811431	1206
20		1/6/90	811432	1206
25		1/6/90	811433	1206
32		1/6/90	811434	1206
40		1/6/90	811435	1648
50		1/6/90	811436	1770
63		1/6/90	811437	1770

OPTIPRO DC MCB WITH EXTENDED LINK AS PER RDSO

HSN Code: 8536

	Rating (A)	Pack	Cat. Nos.	Unit Price (₹)
	0.5	1/-/48	811451	694
	1	1/-/48	811452	694
	1.5	1/-/48	811453	694
	1.6	1/-/48	811454	694
	2	1/-/48	811455	694
	2.5	1/-/48	811456	694
	3	1/-/48	811457	694
	4	1/-/48	811458	694
	5	1/-/48	811459	694
	6	1/-/48	811460	652
	7.5	1/-/48	811461	652
	10	1/-/48	811462	652
	15	1/-/48	811463	652
	16	1/-/48	811464	652
	20	1/-/48	811465	652
	25	1/-/48	811466	652
	30	1/-/48	811467	652
	35	1/-/48	811468	862
	40	1/-/48	811469	862
	50	1/-/48	811470	862
60	1/-/48	811471	862	

—optipro™— **ISOLATOR**

- Conforms to IEC 60947-3 • CE Marked • Degree of Protection IP 20 • 35 sq. mm Terminals • Biconnect Terminals
- Frequency: 50 Hz • Operating Voltage: 240V/415V AC, 60V DC per Pole

DOUBLE POLE

HSN Code: 8536

	Rating (A)	Pack	Cat. Nos.	Unit Price (₹)
	40	1/6/90	811550	622
	63	1/6/90	811551	768
	80	1/6/90	811552	990
	100	1/6/90	811553	990
	125	1/6/90	811554	1068

THREE POLE

HSN Code: 8536

	Rating (A)	Pack	Cat. Nos.	Unit Price (₹)
	40	1/4/60	811555	1162
	63	1/4/60	811556	1330
	80	1/4/60	811557	1498
	100	1/4/60	811558	1498
	125	1/4/60	811559	1644

FOUR POLE

HSN Code: 8536

	Rating (A)	Pack	Cat. Nos.	Unit Price (₹)
	40	1/3/45	811560	1388
	63	1/3/45	811561	1498
	80	1/3/45	811562	1860
	100	1/3/45	811563	1860
	125	1/3/45	811564	2012

—optipro™— **RESIDUAL CURRENT CIRCUIT BREAKER - RCCB**

- ISI/CE marked as per IS/IEC 12640-1 • Degree of Protection IP 20 • Rated Conditional Short-Circuit Current, Icc10kA
- 35 sq. mm Terminals • Biconnect Terminals • Frequency: 50 Hz • Operating Voltage: 240V/415V AC

DOUBLE POLE

HSN Code: 8536

	Rating (A)	Sensitivity (mA)	Pack	Cat. Nos.	Unit Price (₹)
	25	30	1/6/90	811700	3478
		100	1/6/90	811706	3478
		300	1/6/90	811712	3622
	40	30	1/6/90	811701	3572
		100	1/6/90	811707	3572
		300	1/6/90	811713	3894
	63	30	1/6/90	811702	4776
		100	1/6/90	811708	4776
		300	1/6/90	811714	4880

FOUR POLE

HSN Code: 8536

	Rating (A)	Sensitivity (mA)	Pack	Cat. Nos.	Unit Price (₹)
	25	30	1/3/45	811718	4460
		100	1/3/45	811724	4460
		300	1/3/45	811730	4630
	40	30	1/3/45	811719	4576
		100	1/3/45	811725	4576
		300	1/3/45	811731	4828
	63	30	1/3/45	811720	4950
		100	1/3/45	811726	4950
		300	1/3/45	811732	5038

—optipro™— **RCD ADD ON BLOCK**

- Conforms to IEC 60947-2 • Degree of Protection IP 20
- Rated Conditional Short-Circuit Current, Icc 10kA • 35 sq. mm Terminals • Dual Position DIN Clip

DOUBLE POLE

HSN Code: 8536

	Rating (A)	Sensitivity (mA)	Pack	Cat. Nos.	Unit Price (₹)
	6A - 32A		30	1/ - /32	811666
		100	1/ - /32	811668	3592
		300	1/ - /32	811670	3866
40A & 63A		30	1/ - /32	811667	3866
		100	1/ - /32	811669	4248
		300	1/ - /32	811671	4636

FOUR POLE

HSN Code: 8536

	Rating (A)	Sensitivity (mA)	Pack	Cat. Nos.	Unit Price (₹)
	6A - 32A		30	1/ - /16	811672
		100	1/ - /16	811674	4078
		300	1/ - /16	811676	4254
40A & 63A		30	1/ - /16	811673	4376
		100	1/ - /16	811675	4758
		300	1/ - /16	811677	5132

—optipro™— **ACCESSORIES**

HSN Code: 8538

- Conforms to IEC 60947 - 5 - 1 • Retro Fit Type Clip On Accessory • CE Marked
- Upto Three Number of Accessory on a Modular Device • Common Accessories for Entire Range • Easy To Install

	Item Description	Pack	Cat. Nos.	Unit Price (₹)
		Auxiliary Changeover Switch 1NC	1	811580
	Fault Signalling Contact 1NC	1	811581	1116
	Shunt Trip 12V to 48V AC/DC	1	811582	1922
	Shunt Trip 110V to 415V AC	1	811583	1922
	Undervoltage 24V & 48V AC/DC	1	811584	1678
	Undervoltage 240V AC	1	811585	1678



Engineered to perfection
with a wide range and
unmatched quality.

NOW IN A SLEEK

NEW

WHITE FINISH

— **optipro**™ —

ALL THAT YOU NEED



INDEPENDENT
SHIELD FOR EASE
OF MAINTENANCE



ENHANCED
ELEGANCE AND
AESTHETICS



WIDE RANGE
FOR DIFFERENT
APPLICATIONS



SPLIT NEUTRAL
ENHANCING SAFETY



IP PROTECTION
UPTO IP54

—optipro™— **DISTRIBUTION BOARDS (DBs)**

SPN DB-SINGLE DOOR

HSN Code: 8537

- IP : 30 Protection
- Door Earthing
- Isolated Neutral Bar
- Mechanical Impact Strength IK 08
- Cement Spill Protector

	Ways	Modules	Cat Ref.	Unit Price (₹)
	4	4	811800	1498
	6	6	811801	1568
	8	8	811802	1836
	12	12	811803	2150
	16	16	811804	2686

SPN DB-DOUBLE DOOR

HSN Code: 8537

- IP : 43 Protection
- Door Earthing
- Isolated Neutral Bar
- Mechanical Impact Strength IK 09
- Cement Spill Protector

	Ways	Modules	Cat Ref.	Unit Price (₹)
	4	4	811805	2238
	6	6	811806	2418
	8	8	811807	2506
	10	10	811812	2866
	12	12	811808	3022
	14	14	811810	3312
	16	16	811809	3670
	18	18	811811	4030

SPN DB -DOUBLE DOOR

HSN Code: 8537

- IP : 54 Protection
- Door Earthing
- Isolated Neutral Bar
- Mechanical Impact Strength IK 09
- Cement Spill Protector

	Ways	Modules	Cat Ref.	Unit Price (₹)
	4	4	811824	3480
	6	6	811825	4250
	8	8	811826	4542
	12	12	811828	5874
16	16	811829	7252	

SPN DB-ACRYLIC DOOR

HSN Code: 8537

- IP : 43 Protection
- Door Earthing
- Isolated Neutral Bar
- Cement Spill Protector

	Ways	Modules	Cat Ref.	Unit Price (₹)
	4	4	811816	2372
	6	6	811817	2824
	8	8	811818	2982
	12	12	811819	3662
16	16	811820	4520	

—optipro™— **DISTRIBUTION BOARDS (DBs)**

TPN DB-SINGLE DOOR

HSN Code: 8537

- IP : 30 Protection
- Door Earthing
- Isolated Neutral Bar
- Mechanical Impact Strength IK 08
- Cement Spill Protector

	Ways	Modules	Cat Ref.	Unit Price (₹)
	4 Way compact	4+12	4+12	811832
4 Way	8+12	8+12	811833	3942
6 Way compact	4+18	4+18	811834	4566
6 Way	8+18	8+18	811835	4878
8 Way	8+24	8+24	811836	5776
12 Way	8+36	8+36	811837	8304
16 Way	8+48	8+48	811838	10230

TPN DB-DOUBLE DOOR

HSN Code: 8537

- IP : 43 Protection
- Door Earthing
- Isolated Neutral Bar
- Mechanical Impact Strength IK 09
- Cement Spill Protector

	Ways	Modules	Cat Ref.	Unit Price (₹)
	4 Way compact	4+12	4+12	811840
4 Way	8+12	8+12	811841	4904
6 Way compact	4+18	4+18	811842	5762
6 Way	8+18	8+18	811843	6124
8 Way	8+24	8+24	811844	7344
12 Way	8+36	8+36	811845	11004
16 Way	8+48	8+48	811846	13672

TPN DB-DOUBLE DOOR

HSN Code: 8537

- IP : 54 Protection
- Door Earthing
- Isolated Neutral Bar
- Mechanical Impact Strength IK 09
- Cement Spill Protector

	Ways	Modules	Cat Ref.	Unit Price (₹)
	4 Way compact	4+12	4+12	811856
4 Way	8+12	8+12	811857	9854
6 Way compact	4+18	4+18	811858	11298
6 Way	8+18	8+18	811859	12316
8 Way	8+24	8+24	811860	15298
12 Way	8+36	8+36	811861	21738
16 Way	8+48	8+48	811862	25986

TPN DB-ACRYLIC DOOR

HSN Code: 8537

- IP : 43 Protection
- Door Earthing
- Isolated Neutral Bar
- Cement Spill Protector

	Ways	Modules	Cat Ref.	Unit Price (₹)
	4 Way compact	4+12	4+12	811848
4 Way	8+12	8+12	811849	6372
6 Way compact	4+18	4+18	811850	7412
6 Way	8+18	8+18	811851	7954
8 Way	8+24	8+24	811852	9896
12 Way	8+36	8+36	811853	14010
16 Way	8+48	8+48	811854	16924

—optipro™— DISTRIBUTION BOARDS (DBs)

VTPN MCB DB-SINGLE DOOR

HSN Code: 8537

- IP : 30 Protection
- Door Earthing
- Isolated Neutral Bar
- Mechanical Impact Strength IK 08
- Insulated busbar assembly

	Ways	Modules	Cat Ref.	Unit Price (₹)
	4 Way	8 + 12	811864	10676
	6 Way	8 + 18	811865	11730
	8 Way	8 + 24	811866	13050
	12 Way	8 + 36	811867	17548

VTPN MCB DB-DOUBLE DOOR

- IP : 43 Protection
- Door Earthing
- Isolated Neutral Bar
- Mechanical Impact Strength IK 09
- Insulated busbar assembly

	Ways	Modules	Cat Ref.	Unit Price (₹)
	4 Way	8 + 12	811870	12000
	6 Way	8 + 18	811871	14260
	8 Way	8 + 24	811872	15648
	12 Way	8 + 36	811873	20034

VTPN MCB DB -DOUBLE DOOR

HSN Code: 8537

- IP : 54 Protection
- Door Earthing
- Isolated Neutral Bar
- Mechanical Impact Strength IK 09
- Cement Spill Protector

	Ways	Modules	Cat Ref.	Unit Price (₹)
	4 Way	8 + 12	811882	18440
	6 Way	8 + 18	811883	23080
	8 Way	8 + 24	811884	28070
	12 Way	8 + 36	811885	35300

VTPN MCCB 125A DB-DOUBLE DOOR

HSN Code: 8537

- IP : 43 Protection
- Door Earthing
- Isolated Neutral Bar
- Mechanical Impact Strength IK 09
- Insulated busbar assembly
- Suitable for MCCB's upto 125A as I/C (Frame1)

	Ways	Modules	Cat Ref.	Unit Price (₹)
	4 Way	Optium F1 + 12	811888	13900
	6 Way	Optium F1 + 18	811889	15718
	8 Way	Optium F1 + 24	811890	17160
	12 Way	Optium F1 + 36	811891	23370

VTPN MCCB 125A DB -DOUBLE DOOR

HSN Code: 8537

- IP : 54 Protection
- Door Earthing
- Isolated Neutral Bar
- Mechanical Impact Strength IK 09
- Cement Spill Protector
- Suitable for MCCB's upto 125A as I/C (Frame1)

	Ways	Modules	Cat Ref.	Unit Price (₹)
	4 Way	Optium F1 + 12	812040	23080
	6 Way	Optium F1 + 18	812041	26110
	8 Way	Optium F1 + 24	812042	27932
	12 Way	Optium F1 + 36	812043	37662

—optipro™— DISTRIBUTION BOARDS (DBs)

VTPN MCCB 250A DB-DOUBLE DOOR

HSN Code: 8537

- IP : 43 Protection
- Door Earthing
- Isolated Neutral Bar
- Mechanical Impact Strength IK 09
- Insulated busbar assembly
- Suitable for MCCB's upto 250A as I/C (Frame 2)

	Ways	Modules	Cat Ref.	Unit Price (₹)
	4 Way	Optium F2+ 12	811893	19490
	6 Way	Optium F2+ 18	811894	20710
	8 Way	Optium F2+ 24	811895	22904
	12 Way	Optium F2+ 36	811896	29134

VTPN MCCB 250A DB -DOUBLE DOOR

HSN Code: 8537

- IP : 54 Protection
- Door Earthing
- Isolated Neutral Bar
- Mechanical Impact Strength IK 09
- Cement Spill Protector
- Suitable for MCCB's upto 250A as I/C (Frame 2)

	Ways	Modules	Cat Ref.	Unit Price (₹)
	4 Way	Optium F2+ 12	812045	37442
	6 Way	Optium F2+ 18	812046	39946
	8 Way	Optium F2+ 24	812047	44162
	12 Way	Optium F2+ 36	812048	49610

FLEXI DB-DOUBLE DOOR

HSN Code: 8537

- IP : 43 Protection
- Door Earthing
- Isolated Neutral Bar
- Mechanical Impact Strength IK 09
- Cement Spill Protector

	Ways	Modules	Cat Ref.	Unit Price (₹)
	14 X 2 Row	28	811912	6274
	14 X 3 Row	42	811913	7472
	14 X 4 Row	56	811915	8294

FLEXI DB -DOUBLE DOOR

HSN Code: 8537

- IP : 54 Protection
- Door Earthing
- Isolated Neutral Bar
- Mechanical Impact Strength IK 09
- Cement Spill Protector

	Ways	Modules	Cat Ref.	Unit Price (₹)
	14 X 2 Row	28	812030	10208
	14 X 3 Row	42	812031	12446
	14 X 4 Row	56	812033	13724

—optipro™— DISTRIBUTION BOARDS (DBs)

7 SEGMENT DB-DOUBLE DOOR

HSN Code: 8537

- IP : 43 Protection
- Door Earthing
- Isolated Neutral Bar
- Mechanical Impact Strength IK 09
- Compartmentalized solution

	Ways	Modules	Cat Ref.	Unit Price (₹)
	4 Way	8 + 12 + 12	811925	12282
	6 Way	8 + 12 + 18	811926	13768
	8 Way	8 + 12 + 24	811927	15520
	12 Way	8 + 12 + 36	811928	19200
	16 Way	8 + 12 + 48	811929	19734

PHASE SELECTOR DB 40A DOUBLE DOOR

HSN Code: 8537

- IP : 43 Protection
- Door Earthing
- 40 A prefitted selector switch
- Mechanical Impact Strength IK 09
- Isolated Neutral Bar

	Ways	Modules	Cat Ref.	Unit Price (₹)
	4 Way	8 + 12	811940	14408
	6 Way	8 + 18	811941	15042
	8 Way	8 + 24	811942	16316
	12 Way	8 + 36	811943	18094

PHASE SELECTOR DB 63A DOUBLE DOOR

HSN Code: 8537

- IP : 43 Protection
- Door Earthing
- 63 A prefitted selector switch
- Mechanical Impact Strength IK 09
- Isolated Neutral Bar

	Ways	Modules	Cat Ref.	Unit Price (₹)
	4 Way	8 + 12	811950	16624
	6 Way	8 + 18	811951	17346
	8 Way	8 + 24	811952	18294
	12 Way	8 + 36	811953	20576

METAL CLAD P&S

HSN Code: 8537

- IP : 30 Protection
- Without MCBs
- Mechanical Impact Strength IK 08

	Ways	Modules	Cat Ref.	Unit Price (₹)
	20A 2P+E	1 Mod	811955	1656
	20A 2P+E	2 Mod	811956	1656
	20A 3P+E	3 Mod	811957	3600
	32A 3P+E	3 Mod	811958	4280

—optipro™— **DISTRIBUTION BOARDS (DBs)**

TV/TEL DB

HSN Code: 8537

- IP : 43 Protection
- Door Earthing
- Factory fitted KRONE type TV & TEL socket
- Mechanical Impact Strength IK 09
- Isolated & Shrouded Neutral Bar

	Ways	Modules	Cat Ref.	Unit Price (₹)
	8 Way SPN	8	811963	4852
	12 Way SPN	12	811964	5466
	16 Way SPN	16	811965	6234
	4 Way TPN	8+12	811967	8082
	6 Way TPN	8+18	811983	9092
	8 Way TPN	8+24	811968	10188

PPI DB-DOUBLE DOOR

HSN Code: 8537

- IP : 43 Protection
- Door Earthing
- Isolated Neutral Bar for individual phase
- Mechanical Impact Strength IK 09
- Cement Spill Protector

	Ways	Modules	Cat Ref.	Unit Price (₹)
	Hori 4+2 Way	8+6+12	811971	8300
	Hori 6+2 Way	8+6+18	811972	10188
	Hori 8+2 Way	8+6+24	811973	12056
	Hori 12+2 Way	8+6+36	811998	14850
	Tier 6+2 Way	8+6+18	811974	9860
	Tier 8+2 Way	8+6+24	811975	12298
	Tier 12+2 Way	8+6+36	811976	14648

PPI DB-DOUBLE DOOR

HSN Code: 8537

- IP :54 Protection
- Door Earthing
- Isolated Neutral Bar
- Mechanical Impact Strength IK 09
- Cement Spill Protector

	Ways	Modules	Cat Ref.	Unit Price (₹)
	Hori 4+2 Way	8+6+12	812034	16140
	Hori 6+2 Way	8+6+18	812035	19788
	Hori 8+2 Way	8+6+24	812036	22430
	Tier 6+2 Way	8+6+18	812037	16364
	Tier 8+2 Way	8+6+24	812038	20438
	Tier 12+2 Way	8+6+36	812039	23774

PLASTIC P&S

HSN Code: 8537

- IP : 30 Protection
- Without MCBs

	Ways	Modules	Cat Ref.	Unit Price (₹)
	16A 2P+E	2 Mod	811959	3272
	32A 2P+E	2 Mod	811960	3362
	32A 3P+N+E	4 Mod	811961	5380
	63A 3P+N+E	4 Mod	811962	14186

—optipro™— **DISTRIBUTION BOARDS (DBs)**

ENCLOSURES

HSN Code: 8537

	Ways	Modules	Cat Ref.	Unit Price (₹)
	1/2 Mod plastic	2	811977	220
	3/4 Mod plastic	4	811978	372
	1 Mod metal	1	811979	548
	2 Mod metal	2	811980	548
	3 Mod metal	3	811981	726
	4 Mod metal	4	811982	726

CABLE END BOX

HSN Code: 8537

- IP : 43 Protection
- Mechanical Impact Strength IK08

	Description	Cat Ref.	Unit Price (₹)
	CEB SPN DD 4W DB	812000	998
	CEB SPN DD 6W DB	812001	1068
	CEB SPN DD 8W DB	812002	1138
	CEB SPN DD 10W DB	812003	1272
	CEB SPN DD 12W DB	812004	1340
	CEB SPN DD 14W DB	812005	1432
	CEB SPN DD 16W DB	812006	1612
	CEB SPN DD 18W DB	812007	1728
	CEB TPN DD 4W 4 POLE I/C DB	812008	1226
	CEB TPN DD 4W 8 POLE I/C DB or CEB TPN 6W4P I/C DB	812009	1476
	CEB TPN DD 6W 8P I/C DB or PPI HORI. DD DB 4+2W	812010	1748
	CEB TPN DD 8W DB or PPI HORI. DD DB 6+2W	812011	2156
	CEB TPN DD 10W DB or PPI HORI. DD DB 8+2W	812012	2520
	CEB TPN DD 12W DB	812013	2952
	CEB TPN DD 16W DB	812014	3020
	CEB VTPN MCB I/C DB or VTPN MCCB I/C DD DB	812015	2360
	CEB FLEXY DD 14 MOD. PER ROW DB	812017	2134
	CEB PPI TIER 6+2W	812018	2112
	CEB PPI TIER 8+2W	812019	2498
CEB PPI TIER 12+2W	812020	2634	

MCCB ENCLOSURE

- Solid Neutral Link for 3 Pole MCCBs

	Description	Pack	Cat. Nos.	Unit Price (₹)
	Optipro Enclosure for Frame-1 Optium 3 Pole MCCB	1	811984	2066
	Optipro Enclosure for Frame-1 Optium 4 Pole MCCB	1	811985	2066
	Optipro Enclosure for Frame-2 Optium 3 Pole MCCB	1	811986	3112
	Optipro Enclosure for Frame-2 Optium 4 Pole MCCB	1	811987	3112
	Optipro Enclosure for Frame-3 Optium 3 Pole MCCB	1	811988	3112
	Optipro Enclosure for Frame-3 Optium 4 Pole MCCB	1	811989	3112
	Optipro Enclosure for Frame-4 Optium 3 Pole MCCB	1	811990	7746
	Optipro Enclosure for Frame-4 Optium 4 Pole MCCB	1	811991	7746

**BUSBAR CHAMBER
TPN BBC (Cu-Busbar)**

HSN Code: 8536

	<p>Solution for safe Power Distribution</p> <ul style="list-style-type: none"> • Step type design • Available in both SPN & TPN configuration 	Item Description	Ingress Protection*	Cat Ref.	Unit Price* (₹)
		Spl. 32A TPN BBC (Cu) with 4 o/g ways	IP42	CPPI1015	8438
		Spl. 63A TPN BBC (Cu) with 4 o/g ways	IP42	CPPI1016	9412
		Spl. 100A TPN BBC (Cu) with 4 o/g ways	IP42	CPPI1017	10428
		Spl. 200A TPN BBC (Cu) with 4 o/g ways	IP42	CPPI1018	12898
		Spl. 250A TPN BBC (Cu) with 4 o/g ways	IP42	CPPI1019	18356
		Spl. 320A TPN BBC (Cu) with 4 o/g ways	IP42	CPPI1020	22302
		Spl. 400A TPN BBC (Cu) with 4 o/g ways	IP42	CPPI1021	24782
		Spl. 630A TPN BBC (Cu) with 4 o/g ways	IP42	CPPI1022	39644

*Also available in IP54 design

**BUSBAR CHAMBER
TPN-Type (Al.Busbar)**

HSN Code: 8536

	<p>Solution for safe Power Distribution</p> <ul style="list-style-type: none"> • Step type design • Available in both SPN & TPN configuration 	Item Description	Ingress Protection*	Cat Ref.	Unit Price* (₹)
		Spl. 32A TPN BBC (Al.) with 4 o/g ways	IP42	CPPI1023	7932
		Spl. 63A TPN BBC (Al.) with 4 o/g ways	IP42	CPPI1024	8438
		Spl. 100A TPN BBC (Al.) with 4 o/g ways	IP42	CPPI1025	8904
		Spl. 200A TPN BBC (Al.) with 4 o/g ways	IP42	CPPI1026	9412
		Spl. 250A TPN BBC (Al.) with 4 o/g ways	IP42	CPPI1027	11376
		Spl. 320A TPN BBC (Al.) with 4 o/g ways	IP42	CPPI1028	12390
		Spl. 400A TPN BBC (Al.) with 4 o/g ways	IP42	CPPI1029	12898
		Spl. 630A TPN BBC (Al.) with 4 o/g ways	IP42	CPPI1008	22166

*Also available in IP54 design

**METAL CLAD PLUG & SOCKET
AC PLUG**

HSN Code: 8536

	Rating	Pack	Cat. Nos.	Unit Price (₹)
	10A 2P+E, 230V AC	1/10/100	810385	196
	20A 2P+E, 230V AC	1/10/100	810386	210
	20A 3P+E, 230V / 415V AC	1/10/100	810387	286
	32A 3P+E, 230V / 415V AC	1/10/100	810388	516

AC SOCKET

HSN Code: 8536

	Rating	Pack	Cat. Nos.	Unit Price (₹)
	10A 2P+E, 230V AC	1/10/100	810389	196
	20A 2P+E, 230V AC	1/10/100	810390	226
	20A 3P+E, 230V / 415V AC	1/10/100	810391	298
	32A 3P+E, 230V / 415V AC	1/10/100	810392	516

TIME SWITCHES

ANALOG TIME SWITCHES (with battery back up)

HSN Code: 9107

	Model Name	Description	Cat Ref.	Unit Price (₹)
	1mod DIN Daily	1P Module, 24 hours program, Programmable every 15 min., backup of 100 hours, current capacity 16A, with 1 changeover (1 CO)	TA916422	4198
	3mod DIN Daily	3P Module, 24 hours program, Programmable every 15 min., backup of 100 hrs., current capacity 16A, with 1 changeover (1 CO)	TA926453	4574

DIGITAL TIME SWITCHES

HSN Code: 9107

	Model Name	Description	Cat Ref.	Unit Price (₹)
	DIN Type Daily / Weekly with 1 CO	Programmable every 1 min., with backup of 6 years, 28 memory locations, current capacity 16A, weekly program, with 1 changeover (1 CO), Total 28 programs	TDA43110	5558
	DIN Type Daily / Weekly with 2 CO	Programmable every 1 min., with backup of 6 years, 28 memory locations, current capacity 16A, weekly program, with 2 changeover (2 CO), Total 14 programs per channel	TDA43111	8342
	DIN Type Astronomical with 1 CO	Astronomical Programmable every 1 min., backup of 6 years, 28 memory locations, current capacity 16A, with 1 changeover (1 CO), Total 28 programs	TDA45163	11572
	DIN Type Astronomical with 2 CO	Astronomical Programmable every 1 min., backup of 6 years, 28 memory locations, current capacity 16A, with 2 changeover (2 CO), Total 14 programs per channel	TDA45164	14458

LIGHT SENSITIVE SWITCHES

HSN Code: 9107

	Model Name	Description	Cat Ref.	Unit Price (₹)
	1mod DIN Light	Light sensitive switch with outer sensor, sensitive distance 50m,	TSA58107	9642

TIMELITE DISTRIBUTION BOARDS

HSN Code: 8537

	Description	Cat Ref.	Unit Price (₹)
	Timelite-16A 3Pole/230V-Analog Time switch	TL016AB0	27118
	Timelite-32A 3Pole/230V-Analog Time switch	TL032AB0	29334
	Timelite-32A 3Pole/230V-Digital Time Switch	TL032DB0	32016
	Timelite-32A 3Pole/230V-Astronomical Time Switch	TL032AS0	37360
	Timelite-40A 3Pole/230V-Analog Time Switch	TL040AB0	31600
	Timelite-40A 3Pole/230V-Digital Time Switch	TL040DB0	34226
	Timelite-40A 3Pole/230V-Astronomical Time Switch	TL040AS0	39576
	Timelite-65A 3Pole/230V-Analog Time Switch	TL065AB0	40452
	Timelite-65A 3Pole/230V-Digital Time Switch	TL065DB0	43124
	Timelite-65A 3Pole/230V-Astronomical Time Switch	TL065AS0	48448
	Timelite-110A 3Pole/230V-Analog Time Switch	TL110AB0	67720
	Timelite-110A 3Pole/230V-Digital Time Switch	TL110DB0	69784
	Timelite-110A 3Pole/230V-Astronomical Time Switch	TL110AS0	75828
The analog time switch which will be used in Timelite DBs is TA926453 The digital time switch which will be used in Timelite DBs is TDA43110 The astronomical time switch which will be used in Timelite DBs is TDA45163			

GSM based SMART Timelite DB's are also available on request.

AUTOMATIC CHANGEOVER WITH CURRENT LIMITER

- As per IEC60947-6-1
- Intelligent micro controller based Design
- RoHS Compliant

HSN Code: 8536

	Rating (A)	Pack	Cat. Nos.	Unit Price (₹)
	SPN 30A Mains 1.5A DG ACCL	1/3/45	810409	2268
	SPN 30A Mains 2.5A DG ACCL	1/3/45	810410	2268
	SPN 30A Mains 3A DG ACCL	1/3/45	810400	2268
	SPN 30A Mains 4A DG ACCL	1/3/45	810401	2268
	SPN 30A Mains 5A DG ACCL	1/3/45	810402	2268
	SPN 30A Mains 6A DG ACCL	1/3/45	810403	2268
	SPN 30A Mains 9A DG ACCL	1/3/45	810404	2268
	SPN 30A Mains 12A DG ACCL	1/3/45	810405	2268
	SPN 30A Mains 15A DG ACCL	1/3/45	810406	2268
	SPN 30A Mains 20A DG ACCL	1/3/45	810407	2268
	SPN 30A Mains 30A DG ACCL	1/3/45	810408	2268

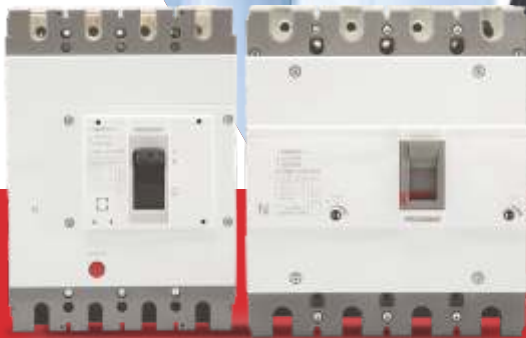

Ensuring reliable performance at high ambient & humid environments.

— optium™ —

ALL THAT YOU NEED

MCCB



WIDE RANGE
16A TO 1250A



OVERLOAD SHORT
CIRCUIT & GROUND
FAULT PROTECTION



BETTER CLEARANCE
WITH COPPER SPREADERS



NO DERATING
UPTO 50°C

—optium™— **OPTIUM 1.0 (FIXED TM MCCB RANGE)**

- Ics =50% Icu as per IEC 60947-II
- Suitable for isolation
- Class II front face
- Fixed Overload & fixed short circuit setting

HSN Code: 8536

Image	Frame	Breaking capacity	Rating	3P	Unit Price (₹)	4P	Unit Price (₹)
		F1	10kA	16	830701	2938	830710
F1		10kA	25	830702	2938	830711	3566
F1		10kA	32	830703	2938	830712	3566
F1		10kA	40	830704	2938	830713	3566
F1		10kA	50	830705	2938	830714	3566
F1		10kA	63	830706	2938	830715	3566
F1		10kA	80	830707	3310	830716	4234
F1		10kA	100	830708	3324	830717	4256
F1		10kA	125	830709	4742	830718	6126

HSN Code: 8536

Image	Frame	Breaking capacity	Rating	3P	Unit Price (₹)	4P	Unit Price (₹)
		F1	16kA	16	830001	4890	830015
F1		16kA	25	830002	4890	830016	5972
F1		16kA	32	830003	4890	830017	5972
F1		16kA	40	830004	4890	830018	5972
F1		16kA	50	830005	4890	830019	5972
F1		16kA	63	830006	4890	830020	5972
F1		16kA	80	830007	5136	830021	6612
F1		16kA	100	830008	5136	830022	6612
F1		16kA	125	830009	7114	830023	9350

HSN Code: 8536

Image	Frame	Breaking capacity	Rating	3P	Unit Price (₹)	4P	Unit Price (₹)
		F1	25kA	16	830031	5886	830045
F1		25kA	25	830032	5886	830046	7036
F1		25kA	32	830033	5886	830047	7036
F1		25kA	40	830034	5886	830048	7036
F1		25kA	50	830035	5886	830049	7036
F1		25kA	63	830036	5886	830050	7036
F1		25kA	80	830037	6060	830051	7384
F1		25kA	100	830038	6060	830052	7384
F1		25kA	125	830039	7298	830053	9712

HSN Code: 8536

Image	Frame	Breaking capacity	Rating	3P	Unit Price (₹)	4P	Unit Price (₹)
		F1	36kA	16	830061	7792	830075
F1		36kA	25	830062	7792	830076	8910
F1		36kA	32	830063	7792	830077	8910
F1		36kA	40	830064	7792	830078	8910
F1		36kA	50	830065	7792	830079	8910
F1		36kA	63	830066	7792	830080	8910
F1		36kA	80	830067	7910	830081	9392
F1		36kA	100	830068	7910	830082	9392
F1		36kA	125	830069	10900	830083	11330

—optium™— **OPTIUM 1.0 (FIXED TM MCCB RANGE)**

HSN Code: 8536

	Frame	Breaking capacity	Rating	3P	Unit Price (₹)	4P	Unit Price (₹)
	F3	50kA	16	830125	9012	830145	10958
	F3	50kA	25	830126	9012	830146	10958
	F3	50kA	32	830127	9012	830147	10958
	F3	50kA	40	830128	9012	830148	10958
	F3	50kA	50	830129	9012	830149	10958
	F3	50kA	63	830130	9012	830150	10958
	F3	50kA	80	830131	9466	830151	11288
	F3	50kA	100	830132	9466	830152	11288
	F3	50kA	125	830133	11044	830153	14004

HSN Code: 8536

	Frame	Breaking capacity	Rating	3P	Unit Price (₹)	4P	Unit Price (₹)
	F2	16kA	160	830090	7598	830095	11024
	F2	16kA	200	830091	9836	830096	12806
	F2	16kA	250	830092	10854	830097	13526
	F2	25kA	160	830100	8994	830105	11046
	F2	25kA	200	830101	12146	830106	14694
	F2	25kA	250	830102	15672	830107	18422
	F2	36kA	160	830110	11062	830115	13556
	F2	36kA	200	830111	14168	830116	17902
	F2	36kA	250	830112	18494	830117	24320

HSN Code: 8536

	Frame	Breaking capacity	Rating	3P	Unit Price (₹)	4P	Unit Price (₹)
	F3	50kA	160	830134	12354	830154	16964
	F3	50kA	200	830135	14870	830155	20874
F3	50kA	250	830136	19122	830156	25406	

HSN Code: 8536

	Frame	Breaking capacity	Rating	3P	Unit Price (₹)	4P	Unit Price (₹)
	F4	36kA	315	830165	24972	830175	28488
	F4	36kA	400	830166	26390	830176	30104
	F4	36kA	500	830167	29532	830177	34174
F4	36kA	630	830168	31302	830178	35970	

HSN Code: 8536

	Frame	Breaking capacity	Rating	3P	Unit Price (₹)	4P	Unit Price (₹)
	F4	50kA	315	830185	25702	830195	30476
	F4	50kA	400	830186	28054	830196	32918
	F4	50kA	500	830187	30502	830197	35378
F4	50kA	630	830188	32334	830198	36660	

HSN Code: 8536

	Frame	Breaking capacity	Rating	3P	MRP	4P	MRP
F5	50kA	800	830200	42130	830201	54416	

—optium™— **OPTIUM 1.1 (FIXED TM MCCB RANGE)**

- Ics = 100% Icu as per IEC 60947-II
- Suitable for isolation
- Class II front face
- Fixed Overload & fixed short circuit setting

HSN Code: 8536

	Frame	Breaking capacity	Rating	3P		4P	
				Unit Price (₹)		Unit Price (₹)	
	F1	16kA	32	840003	5090	840017	6680
	F1	16kA	40	840004	5090	840018	6680
	F1	16kA	63	840006	5090	840020	6680
	F1	16kA	80	840007	5288	840021	7144
	F1	16kA	100	840008	5288	840022	7144
	F1	16kA	125	840009	7418	840023	9970
	F1	25kA	32	840033	6174	840047	7822
	F1	25kA	40	840034	6174	840048	7822
	F1	25kA	63	840036	6174	840050	7822
	F1	25kA	80	840037	6544	840051	7974
	F1	25kA	100	840038	6544	840052	7974
	F1	25kA	125	840039	7570	840053	11186
	F2	16kA	160	840090	7842	840095	11692
	F2	16kA	200	840091	9846	840096	13070
	F2	16kA	250	840092	11220	840097	14980
	F2	25kA	160	840100	9130	840105	12064
	F2	25kA	200	840101	12810	840106	15394
	F2	25kA	250	840102	16560	840107	20694

—optium™— **OPTIUM 2.0 (ADJUSTABLE THERMAL SETTING MCCB)**

- Conforms to IEC 60947-II
- Adjustable Overload Setting Ir = (0.8 to 1.0)In
- Ics = 100% Icu
- Class II front face
- Short Circuit setting fixed
- Suitable for isolation

HSN Code: 8536

	Frame	Breaking capacity	Rating	3P		4P	
				Unit Price (₹)		Unit Price (₹)	
	F1	16kA	25	830222	5178	830236	6916
	F1	16kA	32	830223	5178	830237	6916
	F1	16kA	40	830224	5178	830238	6916
	F1	16kA	50	830225	5178	830239	6916
	F1	16kA	63	830226	5178	830240	6916
	F1	16kA	80	830227	5614	830241	7436
	F1	16kA	100	830228	5614	830242	7436
	F1	16kA	125	830229	7666	830243	10362

HSN Code: 8536

	Frame	Breaking capacity	Rating	3P		4P	
				Unit Price (₹)		Unit Price (₹)	
	F1	25kA	25	830252	6494	830266	8178
	F1	25kA	32	830253	6494	830267	8178
	F1	25kA	40	830254	6494	830268	8178
	F1	25kA	50	830255	6494	830269	8178
	F1	25kA	63	830256	6494	830270	8178
	F1	25kA	80	830257	6814	830271	8578
	F1	25kA	100	830258	6814	830272	8578
	F1	25kA	125	830259	7886	830273	11736

HSN Code: 8536

	Frame	Breaking capacity	Rating	3P		4P	
				Unit Price (₹)		Unit Price (₹)	
	F2	16kA	160	830280	8226	830285	12110
	F2	16kA	200	830281	10250	830286	13572
	F2	16kA	250	830282	11866	830287	16032
	F2	25kA	160	830290	10412	830295	13658
	F2	25kA	200	830291	13326	830296	17192
	F2	25kA	250	830292	17814	830297	22280

—optium™— **OPTIUM 2.0 (ADJUSTABLE TM MCCB RANGE)**

- Ics =100% Icu as per IEC 60947-II
- Adjustable Overload Setting Ir =(0.8 to 1.0)xIn
- Class II front face
- Adjustable Short Circuit Setting Isd =(5 -10)xIn
- Suitable for isolation

HSN Code: 8536

	Frame	Breaking capacity	Rating	3P	Unit Price (₹)	4P	Unit Price (₹)
	F3	36kA	16	830305	8400	830325	11608
F3	36kA	25	830306	8400	830326	11608	
F3	36kA	32	830307	8400	830327	11608	
F3	36kA	40	830308	8400	830328	11608	
F3	36kA	50	830309	8400	830329	11608	
F3	36kA	63	830310	8400	830330	11608	
F3	36kA	80	830311	8566	830331	11950	
F3	36kA	100	830312	8566	830332	11950	
F3	36kA	125	830313	11106	830333	13390	

HSN Code: 8536

	Frame	Breaking capacity	Rating	3P	Unit Price (₹)	4P	Unit Price (₹)
	F3	50kA	16	830345	11312	830365	13520
F3	50kA	25	830346	11312	830366	13520	
F3	50kA	32	830347	11312	830367	13520	
F3	50kA	40	830348	11312	830368	13520	
F3	50kA	50	830349	11312	830369	13520	
F3	50kA	63	830350	11312	830370	13520	
F3	50kA	80	830351	11540	830371	13656	
F3	50kA	100	830352	11540	830372	13656	
F3	50kA	125	830353	12696	830373	16300	

HSN Code: 8536

	Frame	Breaking capacity	Rating	3P	Unit Price (₹)	4P	Unit Price (₹)
	F3	36kA	160	830314	14034	830334	16700
F3	36kA	200	830315	15738	830335	21790	
F3	36kA	250	830316	20674	830336	28538	

HSN Code: 8536

	Frame	Breaking capacity	Rating	3P	Unit Price (₹)	4P	Unit Price (₹)
	F3	50kA	160	830354	14546	830374	18344
F3	50kA	200	830355	16970	830375	23266	
F3	50kA	250	830356	24088	830376	30054	

HSN Code: 8536

	Frame	Breaking capacity	Rating	3P	Unit Price (₹)	4P	Unit Price (₹)
	F4	25kA	315	830385	21982	830387	27686
F4	25kA	400	830386	22508	830388	30206	
F4	36kA	315	830390	26418	830395	32176	
F4	36kA	400	830391	28104	830396	34644	
F4	36kA	500	830392	33078	830397	40614	
F4	36kA	630	830393	35586	830398	45496	
F4	50kA	315	830400	28208	830405	34842	
F4	50kA	400	830401	30104	830406	36586	
F4	50kA	500	830402	34484	830407	42896	
F4	50kA	630	830403	37282	830408	47588	

—optium™— **OPTIUM 2.0 (ADJUSTABLE TM MCCB RANGE)**

HSN Code: 8536

	Frame	Breaking capacity	Rating	3P	Unit Price (₹)	4P	Unit Price (₹)
	F5	36kA	800	830410	43478	830413	53314
	F5	36kA	1000	830411	62618	830414	71626
	F5	36kA	1250	830412	72422	830415	86070
	F5	50kA	800	830416	44760	830419	63772
	F5	50kA	1000	830417	77844	830420	83476
	F5	50kA	1250	830418	85854	830421	96686

—optium™— **OPTIUM 2.1 (ELECTRONIC / MICRO -PROCESSOR MCCB RANGE)**

- Ics =100% Icu as per IEC 60947-II
- Class II front face
- Suitable for isolation
- Adjustable Overload Setting $I_r = (0.4 - 1) \times I_n$
- Adjustable Short circuit Current Setting $I_{sd} = 1.5 - 10 \times I_r$

HSN Code: 8536

	Frame	Breaking capacity	Rating	3P	Unit Price (₹)	4P	Unit Price (₹)
	F3	36kA	40	830430	17892	830440	22532
	F3	36kA	100	830431	18218	830441	22942
	F3	36kA	160	830432	22268	830442	26772
	F3	36kA	250	830433	28098	830443	34080
	F3	50kA	40	830450	20004	830460	24022
	F3	50kA	100	830451	21338	830461	25640
	F3	50kA	160	830452	24278	830462	29686
	F3	50kA	250	830453	31936	830463	39132

—optium™— **OPTIUM 2.1 (ELECTRONIC / MICRO -PROCESSOR MCCB RANGE)**

- Ics =100% Icu as per IEC 60947-II
- Class II front face
- Suitable for isolation
- Transparent cover for trip unit as standard
- Adjustable Neutral pole protection -N,N/2 & Off for 4 pole MCCB
- Innovative front indication LED's(Ready, Overload pre-alarm & Overload)
- Adjustable Overload Setting $I_r = (0.4 - 1) \times I_n$; $T_r = 3-30$ sec
- Adjustable Short circuit Current Setting $I_{sd} = (1.5 - 10) I_r$; $T_{sd} (I=K) = 0-500$ ms; $T_{sd} (I2t=K) = 0-500$ ms

HSN Code: 8536

	Frame	Breaking capacity	Rating	3P	Unit Price (₹)	4P	Unit Price (₹)
	F4	36kA	400	830510	33928	830512	44742
	F4	36kA	630	830511	38230	830513	48572
	F4	50kA	400	830514	41944	830516	53342
F4	50kA	630	830515	43438	830517	56312	

HSN Code: 8536

	Frame	Breaking capacity	Rating	3P	Unit Price (₹)	4P	Unit Price (₹)
	F5	36kA	800	830540	62632	830542	75946
	F5	36kA	1250	830541	94184	830543	119986
	F5	50kA	800	830544	66866	830546	83418
F5	50kA	1250	830545	114976	830547	158952	

—optium™— **OPTIUM 2.2 (WITH ELECTRONIC / MICRO PROCESSOR RELEASE)**

- Ics =100% Icu as per IEC 60947-II
- Class II front face
- Suitable for isolation
- Adjustable Overload Setting $I_r = (0.4 - 1) \times I_n$
- Adjustable Short circuit Current Setting $I_{sd} = (1.5 - 10) \times I_r$
- Ground fault Setting:- $I_g = (0.2 - 1) \times I_n$

HSN Code: 8536

	Frame	Breaking capacity	Rating	3P	Unit Price (₹)	4P	Unit Price (₹)
	F3	36kA	40	830470	21266	830480	26580
	F3	36kA	100	830471	21838	830481	27290
	F3	36kA	160	830472	24530	830482	30396
	F3	36kA	250	830473	31348	830483	38574
	F3	50kA	40	830490	23168	830500	28034
	F3	50kA	100	830491	23790	830501	28404
	F3	50kA	160	830492	27256	830502	33094
	F3	50kA	250	830493	35432	830503	42666

—optium™— **OPTIUM 2.2 (ELECTRONIC / MICRO -PROCESSOR MCCB RANGE)**

- Ics =100% Icu as per IEC 60947-II
- Class II front face
- Suitable for isolation
- Adjustable Neutral pole protection -N,N/2 & Off for 4 pole MCCB
- Innovative front indication LED's(Ready, Overload pre-alarm & Overload)
- Adjustable Overload Setting Ir = 0.4 - 1 x In ; Tr = 3-30 sec
- Adjustable Short circuit Current Setting Isd = 1.5 - 10 Ir ; Tsd (I=K) = 0-500 ms; Tsd (I2t=K) = 0-500 ms
- Ground fault Setting:- Ig = (0.2 - 1) x In ; Tg = (0.1 - 1) s

HSN Code: 8536

	Frame	Breaking capacity	Rating	3P	Unit Price (₹)	4P	Unit Price (₹)
	F4	36kA	400	830520	45116	830522	53492
	F4	36kA	630	830521	51560	830523	65736
	F4	50kA	400	830524	50610	830526	58272
	F4	50kA	630	830525	57204	830527	72998

HSN Code: 8536

	Frame	Breaking capacity	Rating	3P	Unit Price (₹)	4P	Unit Price (₹)
	F5	36kA	800	830550	78442	830552	99088
	F5	36kA	1250	830551	104594	830553	136934
	F5	50kA	800	830554	93584	830556	115150
	F5	50kA	1250	830555	122482	830557	166838

—optium™— **ACCESSORIES**

HSN Code: 8538

	Product	Frame	Cat Ref.	Unit Price (₹)
	Auxiliary contact	F1 F2 F3	830691	1190
	Alarm Contact	F1 F2 F3	830692	1190
	Auxiliary contact / Alarm Contact	F4-F5	830693	1510
	Auxiliary contact / Alarm Contact	F1 F2 F3	830694	1782

HSN Code: 8538

	Product	Frame	Cat Ref.	Unit Price (₹)
	"Shunt trip 24 V AC/DC"	F1 F2 F3	830602	1348
	"Shunt trip 110 V AC/DC"	F1 F2 F3	830603	1348
	"Shunt trip 230 V AC/DC"	F1 F2 F3	830604	1442
	"Shunt trip 415 V AC/DC"	F1 F2 F3	830605	1442
	"Shunt trip 24 V AC/DC"	F4 F5	830642	2562
	"Shunt trip 110 V AC/DC"	F4 F5	830643	2562
	"Shunt trip 230 V AC/DC"	F4 F5	830644	2562
	"Shunt trip 415 V AC/DC"	F4 F5	830645	2562

HSN Code: 8538

	Product	Frame	Cat Ref.	Unit Price (₹)
	"Undervoltage 24 V DC"	F1 F2 F3	830606	2210
	"Undervoltage 110V AC"	F1 F2 F3	830607	2210
	"Undervoltage 230V AC"	F1 F2 F3	830608	2210
	"Undervoltage 415V AC"	F1 F2 F3	830609	2210
	"Undervoltage 24 V DC"	F4 F5	830646	2276
	"Undervoltage 110V AC"	F4 F5	830647	2276
	"Undervoltage 230V AC"	F4 F5	830648	2276
	"Undervoltage 415V AC"	F4 F5	830649	2276

—optium™— ACCESSORIES

HSN Code: 8538

	Product	Frame	Cat Ref.	Unit Price (₹)
	Rotary Handle Direct	F1	830611	1694
	Rotary Handle vary-Depth	F1	830612	1694
	Rotary Handle Direct	F2 F3	830626	1924
	Rotary Handle vary-Depth	F2 F3	830627	1924
	Rotary Handle Direct	F4	830651	2276
	Rotary Handle vary-Depth	F4	830652	2276
	Rotary Handle Direct	F5	830671	4460
	Rotary Handle vary-Depth	F5	830672	4460

HSN Code: 8538

	Product	Frame	Cat Ref.	Unit Price (₹)
	Ronis lock Direct RH	F1 F2 F3	830613	1854
	Ronis lock Vary-Depth RH	F1 F2 F3	830614	1854
	Ronis lock Vary-Depth RH	F4	830653	2420

HSN Code: 8538

	Product	Frame	Cat Ref.	Unit Price (₹)
	Padlock Off position	F1 F2 F3	830615	2526
	Padlock Off position	F4	830654	2444
	Padlock Off position	F5	830674	2444

HSN Code: 8538

	Product	Frame	Cat Ref.	Unit Price (₹)
	Phase insulators 3P	F1 F2	830616	402
	Phase insulators 3P	F3	830628	476
	Phase insulators 3P	F4	830655	832
	Phase insulators 3P	F5	830675	1124
	Phase insulators 4P	F1 F2	830617	600
	Phase insulators 4P	F3	830629	592
	Phase insulators 4P	F4	830656	1020
	Phase insulators 4P	F5	830676	1332

HSN Code: 8538

HSN Code: 8538

	Product	Frame	Cat Ref.	Unit Price (₹)
	Terminal cover 3P	F4	830657	1020
	Terminal cover 3P	F5	830677	1500
	Terminal cover 4P	F4	830658	1500
	Terminal cover 4P	F5	830678	1990
	Terminal shield 3P	F5	830679	2330
	Terminal shield 4P	F5	830680	3158

—optium™— **ACCESSORIES**

HSN Code: 8538

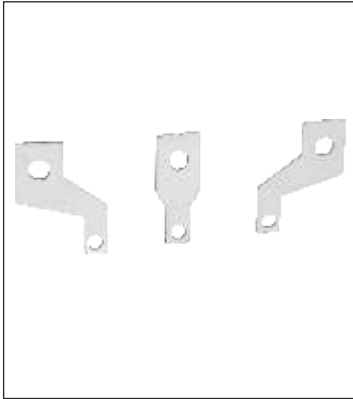

Product	Frame	Cat Ref.	Unit Price (₹)
Spreaders 3P	F1	830618	458
Spreaders 4P	F1	830619	668
Spreaders 3P	F2 F3	830632	1146
Spreaders 4P	F2 F3	830633	2288
Spreaders 3P	F4	830659	3628
Spreaders 4P	F4	830660	5290
Spreaders 3P 800/1000A	F5	830681	9368
Spreaders 4P 800/1000A	F5	830682	14216
Spreaders 3P 1250A	F5	830685	9744
Spreaders 4P 1250A	F5	830686	14362

HSN Code: 8538



Product	Frame	Cat Ref.	Unit Price (₹)
Cages 3P upto 50A	F1	830620	518
Cages 4P upto 50A	F1	830621	696
Cages 3P 63 to 100A	F1	830622	518
Cages 4P 63 to 100A	F1	830623	696
Cages 3P 125A	F1	830624	518
Cages 4P 125A	F1	830625	696
Cages 3P	F2	830630	680
Cages 4P	F2	830631	796
Cages 3P	F3	830634	894
Cages 4P	F3	830635	1184
Cages 3P	F4	830661	1252
Cages 4P	F4	830662	1332
Cages 3P	F5	830683	1366
Cages 4P	F5	830684	1462



**A Versatile and
Reliable Solution**

— optipro[™] SMDB —

**CUSTOMISABLE WITH
CHANGEOVER AND METER OPTIONS
AS PER CUSTOMER NEEDS.**

**MODULAR AND VERSATILE
TO FIT VARIOUS RATINGS AND
CONFIGURATIONS.**

**SUITABLE FOR
COMMERCIAL, RESIDENTIAL,
AND INDUSTRIAL USE.**

**COMPACT DBS WITH MCCB
INCOMER AND OUTGOING.**

**COMPLIES WITH
IEC 61439-1 & 2.**



Optipro SMDB 250 (Single Door) - Main enclosure (with a provision to mount TP MCCBs as an outgoing*) HSN Code: 8536

- Tested as er IEC 61439-2 • Degree of protection IP-30 in Single door & IP-43 in Double door
- 3 Frame sizes - SMDB250, SMDB400, SMDB630 • wide range- 4W, 6W, 8W &12W

Item Description	Type	Cat Ref.	Unit Price (₹)
SMDB250 4W SD ME Optium F2-I/c & TP F1 O/G	SD	812100	44022
SMDB250 6W SD ME Optium F2-I/c & TP F1 O/G	SD	812101	47260
SMDB250 8W SD ME Optium F2-I/c & TP F1 O/G	SD	812102	54277
SMDB250 12W SD ME Optium F2-I/c & TP F1 O/G	SD	812103	64149
SMDB250 4W SD ME Optium F3-I/c & TP F1 O/G	SD	812110	47834
SMDB250 6W SD ME Optium F3-I/c & TP F1 O/G	SD	812111	51351
SMDB250 8W SD ME Optium F3-I/c & TP F1 O/G	SD	812112	58977
SMDB250 12W SD ME Optium F3-I/c & TP F1 O/G	SD	812113	69736

Optipro SMDB 400 (Single Door) - Main enclosure (with a provision to mount TP MCCBs as an outgoing*) HSN Code: 8536

Item Description	Type	Cat Ref.	Unit Price (₹)
SMDB400 4W SD ME Optium F4-I/c & TP F1 O/G	SD	812120	49219
SMDB400 6W SD ME Optium F4-I/c & TP F1 O/G	SD	812121	52814
SMDB400 8W SD ME Optium F4-I/c & TP F1 O/G	SD	812122	60830
SMDB400 12W SD ME Optium F4-I/c & TP F1 O/G	SD	812123	71892
SMDB400 8W SD ME Optium F4-I/c & TP F1-6 & F2-2 O/G	SD	812124	POR
SMDB400 12W SD ME Optium F4-I/c & TP F1-8 & F2-4 O/G	SD	812125	POR
SMDB400 12W SD ME Optium F4-I/c & TP F1-10 & F2-2 O/G	SD	812126	POR

Optipro SMDB 630 (Single Door) - Main enclosure (with a provision to mount TP MCCBs as an outgoing*) HSN Code: 8536

Item Description	Type	Cat Ref.	Unit Price (₹)
SMDB630 4W SD ME Optium F4-I/c & TP F1 O/G	SD	812136	73829
SMDB630 6W SD ME Optium F4-I/c & TP F1 O/G	SD	812137	76592
SMDB630 8W SD ME Optium F4-I/c & TP F1 O/G	SD	812138	88207
SMDB630 12W SD ME Optium F4-I/c & TP F1 O/G	SD	812139	104242
SMDB630 8W SD ME Optium F4-I/c & TP F1-6 & F2-2 O/G	SD	812140	88207
SMDB630 12W SD ME Optium F4-I/c & TP F1-8 & F2-4 O/G	SD	812141	POR
SMDB630 12W SD ME Optium F4-I/c & TP F1-10 & F2-2 O/G	SD	812142	104242

Optipro SMDB 250 (Single Door) - Main enclosure (with a provision to mount FP MCCBs as an outgoing*) HSN Code: 8536

Item Description	Type	Cat Ref.	Unit Price (₹)
SMDB250 4W SD ME Optium F2-I/c & FP F1 O/G	SD	812105	48412
SMDB250 6W SD ME Optium F2-I/c & FP F1 O/G	SD	812106	51962
SMDB250 8W SD ME Optium F2-I/c & FP F1 O/G	SD	812107	59727
SMDB250 12W SD ME Optium F2-I/c & FP F1 O/G	SD	812108	70786
SMDB250 4W SD ME Optium F3-I/c & FP F1 O/G	SD	812115	52616
SMDB250 6W SD ME Optium F3-I/c & FP F1 O/G	SD	812116	56523
SMDB250 8W SD ME Optium F3-I/c & FP F1 O/G	SD	812117	64899
SMDB250 12W SD ME Optium F3-I/c & FP F1 O/G	SD	812118	76926

Optipro SMDB 400 (Single Door) - Main enclosure (with a provision to mount FP MCCBs as an outgoing*) HSN Code: 8536

Item Description	Type	Cat Ref.	Unit Price (₹)
SMDB400 4W SD ME Optium F4-I/c & FP F1 O/G	SD	812128	54195
SMDB400 6W SD ME Optium F4-I/c & FP F1 O/G	SD	812129	58344
SMDB400 8W SD ME Optium F4-I/c & FP F1 O/G	SD	812130	66916
SMDB400 12W SD ME Optium F4-I/c & FP F1 O/G	SD	812131	79359
SMDB400 8W SD ME Optium F4-I/c & FP F1-6 & F2-2 O/G	SD	812132	POR
SMDB400 12W SD ME Optium F4-I/c & FP F1-8 & F2-4 O/G	SD	812133	POR
SMDB400 12W SD ME Optium F4-I/c & FP F1-10 & F2-2 O/G	SD	812134	POR

Optipro SMDB 630 (Single Door) - Main enclosure (with a provision to mount FP MCCBs as an outgoing*) HSN Code: 8536

Item Description	Type	Cat Ref.	Unit Price (₹)
SMDB630 4W SD ME Optium F4-I/c & FP F1 O/G	SD	812144	81296
SMDB630 6W SD ME Optium F4-I/c & FP F1 O/G	SD	812145	84612
SMDB630 8W SD ME Optium F4-I/c & FP F1 O/G	SD	812146	97053
SMDB630 12W SD ME Optium F4-I/c & FP F1 O/G	SD	812147	115028
SMDB630 8W SD ME Optium F4-I/c & FP F1-6 & F2-2 O/G	SD	812148	97053
SMDB630 12W SD ME Optium F4-I/c & FP F1-8 & F2-4 O/G	SD	812149	POR
SMDB630 12W SD ME Optium F4-I/c & FP F1-10 & F2-2 O/G	SD	812150	115028

Optipro SMDB 250 (Double Door) - Main enclosure (with a provision to mount TP MCCBs as an outgoing*)

HSN Code: 8536

	Item Description	Type	Cat Ref.	Unit Price (₹)
	SMDB250 4W DD ME Optium F2-I/c & TP F1 O/G	DD	812181	52146
	SMDB250 6W DD ME Optium F2-I/c & TP F1 O/G	DD	812182	56212
	SMDB250 8W DD ME Optium F2-I/c & TP F1 O/G	DD	812183	64623
	SMDB250 12W DD ME Optium F2-I/c & TP F1 O/G	DD	812184	76179
	SMDB250 4W DD ME Optium F3-I/c & TP F1 O/G	DD	812191	54553
	SMDB250 6W DD ME Optium F3-I/c & TP F1 O/G	DD	812192	58760
	SMDB250 8W DD ME Optium F3-I/c & TP F1 O/G	DD	812193	67584
	SMDB250 12W DD ME Optium F3-I/c & TP F1 O/G	DD	812194	79635

Optipro SMDB 400 (Double Door) - Main enclosure (with a provision to mount TP MCCBs as an outgoing*)

HSN Code: 8536

	Item Description	Type	Cat Ref.	Unit Price (₹)
	SMDB400 4W DD ME Optium F4-I/c & TP F1 O/G	DD	812201	56131
	SMDB400 6W DD ME Optium F4-I/c & TP F1 O/G	DD	812202	60557
	SMDB400 8W DD ME Optium F4-I/c & TP F1 O/G	DD	812203	69676
	SMDB400 12W DD ME Optium F4-I/c & TP F1 O/G	DD	812204	82121
	SMDB400 8W DD ME Optium F4-I/c & TP F1-6 & F2-2 O/G	DD	812205	POR
	SMDB400 12W DD ME Optium F4-I/c & TP F1-8 & F2-4 O/G	DD	812206	POR
	SMDB400 12W DD ME Optium F4-I/c & TP F1-10 & F2-2 O/G	DD	812207	POR

Optipro SMDB 630 (Double Door) - Main enclosure (with a provision to mount TP MCCBs as an outgoing*)

HSN Code: 8536

	Item Description	Type	Cat Ref.	Unit Price (₹)
	SMDB630 4W DD ME Optium F4-I/c & TP F1 O/G	DD	812217	84333
	SMDB630 6W DD ME Optium F4-I/c & TP F1 O/G	DD	812218	87931
	SMDB630 8W DD ME Optium F4-I/c & TP F1 O/G	DD	812219	100924
	SMDB630 12W DD ME Optium F4-I/c & TP F1 O/G	DD	812220	119174
	SMDB630 8W DD ME Optium F4-I/c & TP F1-6 & F2-2 O/G	DD	812221	100924
	SMDB630 12W DD ME Optium F4-I/c & TP F1-8 & F2-4 O/G	DD	812222	POR
	SMDB630 12W DD ME Optium F4-I/c & TP F1-10 & F2-2 O/G	DD	812223	119174

Optipro SMDB 250 (Double Door) - Main enclosure (with a provision to mount FP MCCBs as an outgoing*)

HSN Code: 8536

	Item Description	Type	Cat Ref.	Unit Price (₹)
	SMDB250 4W DD ME Optium F2-I/c & FP F1 O/G	DD	812186	57376
	SMDB250 6W DD ME Optium F2-I/c & FP F1 O/G	DD	812187	61820
	SMDB250 8W DD ME Optium F2-I/c & FP F1 O/G	DD	812188	71088
	SMDB250 12W DD ME Optium F2-I/c & FP F1 O/G	DD	812189	83979
	SMDB250 4W DD ME Optium F3-I/c & FP F1 O/G	DD	812196	60059
	SMDB250 6W DD ME Optium F3-I/c & FP F1 O/G	DD	812197	64645
	SMDB250 8W DD ME Optium F3-I/c & FP F1 O/G	DD	812198	74324
	SMDB250 12W DD ME Optium F3-I/c & FP F1 O/G	DD	812199	87769

Optipro SMDB 400 (Double Door) - Main enclosure (with a provision to mount FP MCCBs as an outgoing*)

HSN Code: 8536

	Item Description	Type	Cat Ref.	Unit Price (₹)
	SMDB400 4W DD ME Optium F4-I/c & FP F1 O/G	DD	812209	61936
	SMDB400 6W DD ME Optium F4-I/c & FP F1 O/G	DD	812210	66638
	SMDB400 8W DD ME Optium F4-I/c & FP F1 O/G	DD	812211	76592
	SMDB400 12W DD ME Optium F4-I/c & FP F1 O/G	DD	812212	90418
	SMDB400 8W DD ME Optium F4-I/c & FP F1-6 & F2-2 O/G	DD	812213	POR
	SMDB400 12W DD ME Optium F4-I/c & FP F1-8 & F2-4 O/G	DD	812214	POR
	SMDB400 12W DD ME Optium F4-I/c & FP F1-10 & F2-2 O/G	DD	812215	POR

Optipro SMDB 630 (Double Door) - Main enclosure (with a provision to mount FP MCCBs as an outgoing*)

HSN Code: 8536

	Item Description	Type	Cat Ref.	Unit Price (₹)
	SMDB630 4W DD ME Optium F4-I/c & FP F1 O/G	DD	812225	92907
	SMDB630 6W DD ME Optium F4-I/c & FP F1 O/G	DD	812226	96499
	SMDB630 8W DD ME Optium F4-I/c & FP F1 O/G	DD	812227	111156
	SMDB630 12W DD ME Optium F4-I/c & FP F1 O/G	DD	812228	131067
	SMDB630 8W DD ME Optium F4-I/c & FP F1-6 & F2-2 O/G	DD	812229	111156
	SMDB630 12W DD ME Optium F4-I/c & FP F1-8 & F2-4 O/G	DD	812230	POR
	SMDB630 12W DD ME Optium F4-I/c & FP F1-10 & F2-2 O/G	DD	812231	131067

Optipro SMDB - Bottom cable Unit (Single Door)

HSN Code: 8536

	Item Description	Type	Cat Ref.	Unit Price (₹)
	Bottom Cable Unit(for SD SMDB's with F1 O/G only)	SD	812152	5278
Bottom Cable Unit(for SD SMDB's with F1 & F2 O/G)	SD	812153	5948	

Optipro SMDB 250 - Cable Alley Unit (Single Door)

HSN Code: 8536

	Item Description	Type	Cat Ref.	Unit Price (₹)
	SMDB250 Cable Alley-4W SD	SD	812154	12499
SMDB250 Cable Alley-6W SD	SD	812155	14735	
SMDB250 Cable Alley-8W SD	SD	812156	15921	
SMDB250 Cable Alley-12W SD	SD	812157	17952	

Optipro SMDB 400/630 - Cable Alley (Single Door)

HSN Code: 8536

	Item Description	Type	Cat Ref.	Unit Price (₹)
	SMDB400/630 Cable Alley-4W SD	SD	812159	17421
SMDB400/630 Cable Alley-6W SD	SD	812160	19194	
SMDB400/630 Cable Alley-8W SD	SD	812161	20762	
SMDB400/630 Cable Alley-12W SD	SD	812162	22754	
SMDB400/630 Cable Alley-8W SD	SD	812163	20762	
SMDB400/630 Cable Alley-12W SD	SD	812164	22754	
SMDB400/630 Cable Alley-12W SD	SD	812165	22754	
Metering Unit(for SD SMDB's with F1 O/G only)- with Ammeter,Voltmeter & Phase Indicators(3nos.)	SD	812167	17479	
Metering Unit (for SD SMDB's with F1 & F2 O/G) - with Ammeter,Voltmeter & Phase Indicators(3nos.)	SD	812168	18944	
Metering Unit(for SD SMDB's with F1 O/G only)- with Multifunction meter, Buzzer & Phase Indicators(3nos.)	SD	812169	21845	
Metering Unit (for SD SMDB's with F1 & F2 O/G) - with Multifunction meter, Buzzer & Phase Indicators(3nos.)	SD	812170	23700	
Corner Unit-SD	SD	812171	2099	

Optipro SMDB - Bottom cable Unit (Double Door)

HSN Code: 8536

	Item Description	Type	Cat Ref.	Unit Price (₹)
	Bottom Cable Unit(for DD SMDB's with F1 O/G only)	DD	812233	5922
Bottom Cable Unit(for DD SMDB's with F1 & F2 O/G)	DD	812234	6663	

Optipro SMDB 250- Cable Alley Unit (Double Door)

HSN Code: 8536

	Item Description	Type	Cat Ref.	Unit Price (₹)
	SMDB250 Cable Alley-6W DD	DD	812236	16509
SMDB250 Cable Alley-8W DD	DD	812237	17838	
SMDB250 Cable Alley-12W DD	DD	812238	20108	

Optipro SMDB 400/630- Cable Alley Unit (Double Door)

HSN Code: 8536

	Item Description	Type	Cat Ref.	Unit Price (₹)
	SMDB400/630 Cable Alley-4W DD	DD	812240	19518
SMDB400/630 Cable Alley-6W DD	DD	812241	21509	
SMDB400/630 Cable Alley-8W DD	DD	812242	23252	
SMDB400/630 Cable Alley-12W DD	DD	812243	25495	
SMDB400/630 Cable Alley-8W DD	DD	812244	23252	
SMDB400/630 Cable Alley-12W DD	DD	812245	25495	
SMDB400/630 Cable Alley-12W DD	DD	812246	25495	
Metering Unit(for DD SMDB's with F1 O/G only)- with Ammeter,Voltmeter & Phase Indicators(3nos.)	DD	812248	22732	
Metering Unit (for DD SMDB's with F1 & F2 O/G) - with Ammeter,Voltmeter & Phase Indicators(3nos.)	DD	812249	24610	
Metering Unit(for DD SMDB's with F1 O/G only)- with Multifunction meter, Buzzer & Phase Indicators(3nos.)	DD	812250	28402	
Metering Unit (for DD SMDB's with F1 & F2 O/G) - with Multifunction meter, Buzzer & Phase Indicators(3nos.)	DD	812251	30751	
Corner Unit-DD	DD	812252	2099	

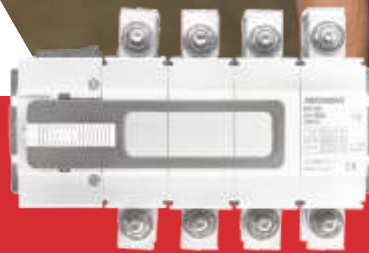

Switch on to Reliable Partner

— optinova™ —

**QUICK AND EASY
INSTALLATION**

**OPERATIONAL VOLTAGE
UPTO 550 V**

**HIGH SHORT TIME WITHSTAND
UPTO 12.5KA FOR 1 SEC**

**HIGH MECHANICAL AND
ELECTRICAL ENDURANCE**

**EXTRA SAFETY WITH ADD
ON ACCESSORIES**



— optinova™ —

Switch Disconnecter



NEW

Transfer Switching Equipment



				Din Frame			Power Frame-1				Power Frame-2		
Performance				IndoAsian OptiNova-SD									
General	Frame	Ith	A	63			160				320		
	Rated currents			32	40	63	63	100	125	160	200	250	320
	Poles	4			4				4				
Electrical	Rated insulation voltage	Ui	V	690			1000				1000		
	Rated Impulse Withstand Voltage	Uimp	kV	8			8				12		
	Rated frequency	50/60			50/60				50/60				
	Short time withstand current @ rated time(s)	t(s)	Icw for 1s	1.5kA			4kA		5kA		10kA		12.5kA

— optinova™ —

4P SWITCH DISCONNECTOR / TRANSFER SWITCHING EQUIPMENT - DIN FRAME HSN Code: 8536

Rated Current	Switch Disconnecter		Transfer Switching Equipment TSE (On Load ChangeOver)	
	Cat Ref.	Unit Price (₹)	Cat Ref.	Unit Price (₹)
	32A	824006	2240	824106
40A	824007	2366	824107	4718
63A	824008	2802	824108	5266

— optinova™ —

4P SWITCH DISCONNECTOR / TRANSFER SWITCHING EQUIPMENT - POWER FRAME HSN Code: 8536

Rated Current	Switch Disconnecter		Transfer Switching Equipment TSE (On Load ChangeOver)		Transfer Switching Equipment TSE (On Load ChangeOver) with Enclosure	
	Cat Ref.	Unit Price (₹)	Cat Ref.	Unit Price (₹)	Cat Ref.	Unit Price (₹)
63A	824082	3910	824182	6138	824192	8928
100A	824083	5452	824183	7638	824193	11674
125A	824084	5892	824184	11458	824194	16404
160A	824085	7466	824185	12772	824195	18032
200A	824086	9342	824186	15264	824196	20966
250A	824087	11732	824187	21834	824197	27918
320A	824088	13022	824188	23252	824198	30090

— optinova™ —

ACCESSORIES - DIN FRAME

HSN Code: 8538

Product	Cat Ref.	Unit Price (₹)
Shorting links 63A for TSE	824201	804
Auxiliary contact Simultaneous (1 NO + 1 NC)	824208	424
Handle Vary Depth KIT IP54	824209	1184
SD Direct Handle	824215	946
TSE Direct Handle	824217	946

— optinova™ —

ACCESSORIES - POWER FRAME

HSN Code: 8538

Product	Frame 1- 160A		Frame 2- 320A	
	Cat Ref.	Unit Price (₹)	Cat Ref.	Unit Price (₹)
Aux contact Simultaneous (4 NO + 4 NC)	824245	1184	824245	1184
Shorting Link for TSE	824249	2270	824241	3400
Phase Barriers	824251	186	824243	238
Inter source barrier for TSE	824252	238	824239	382
Spreader terminals (one side only)	824254	924	824238	1846
Handle Direct	824230	988	824230	988
Handle Vary Depth	824231	1412	824231	1412

HRC FUSE LINKS & BASES

BOLTED TYPE (BS) BREAKING CAPACITY ≥ 80kA 500 V AC 50 Hz.

HSN Code: 8536

Rating	Type	Cat Ref.	Tag Type	Unit Price (₹)	Unit/Carton
2, 4, 6, 8, 10, 16A	FGN	IEFGN***	Offset	98	20
20, 25, 32A	FGN	IEFGN***	Offset	108	20
2, 4, 6, 10, 16, 20, 25, 32A	FSA	IEFSA***	Offset	144	10
35, 40, 50, 63A	FSS	IEFSS***	Offset	164	10
50, 63, 80, 100, 125, 160A	FSDCP	IEDCP***	Offset	348	10
100, 125, 160, 200, 250A	FSFP	IESFP***	Offset	498	3
50, 63, 80, 100, 125A	FSDC	IESDC***	Central	348	10
100, 125, 160, 200, 250A	FSF	IEFSF***	Central	510	3
225, 250, 300, 315, 320A	FSK	IEFSK***	Central	736	3
355, 400A	FMF	IEFMF***	Central	1422	3
355, 400, 450, 500, 560, 600, 630A	FTS	IEFTS***	Central	1642	1
355, 400, 450, 500, 560A	FTM	IEFTM***	2 Central	2120	1
600, 630A	FTM	IEFTM***	2 Central	2914	1

DIN TYPE BREAKING CAPACITY ≥ 80kA 500 V AC 50 Hz.

HSN Code: 8536

Rating Amps	Type	Cat Ref.	Unit Price (₹)	Unit/Carton
2, 4, 6, 10, 16, 20, 25, 32, 50, 63A	Size 000	IWS00***	434	6
2, 4, 6, 10, 16, 20, 25, 32, 36, 40, 50, 63A	Size 00	IW000***	462	6
80, 100A		IW000***	462	6
125, 160A		IW000***	462	6
32, 36, 50, 63, 80, 100, 125, 160, 200A	Size 01	IW001***	846	3
250A		IW001***	846	3
100, 125, 160, 200, 250, 315A	Size 02	IW002***	1240	3
400A		IW002***	1240	3
315, 355, 400, 425A	Size 03	IW003***	1704	3
500, 630A		IW003***	1704	3

* Note HRC fuses with SC breaking capacity 120kA are available on request.

CYLINDRICAL TYPE (IFRH) BREAKING CAPACITY > 80kA 415 V AC.

HSN Code: 8536

Rating	Cat Ref.	Unit Price (₹)
2 to 25A	IFRHO***	184
32 to 40A	IFRHO***	192
50A	IFRH0050	356
63A	IFRH0063	366
Fuse Holder Fr type (2 to 63A)	IFR00***	342

FUSE FITTINGS FOR BOLTED (BS) TYPE

HSN Code: 8536

Rating	Front Connection	Unit Price (₹)	Back Busbar Connection	Unit Price (₹)	Unit/Carton
20A	BFFC 0020	206	BFBC 0020	224	10
32A	BFFC 0032	364	BFBC 0032	378	10
63A	BFFC 0063	524	BFBC 0063	552	5
100A	BFFC 0100	1346	BFBC 0100	1386	3
20A (Stud Type)			BFCS 020	300	1

FUSE BASES FOR DIN TYPE HRC FUSE LINKS

HSN Code: 8536

Rating Amps	Suitable for	Cat Ref.	Unit Price (₹)	Unit/Carton
6-160A	Size - 00	IWFB0***	594	6
32-250A	Size - 1	IWFB1***	1132	2
100-400A	Size - 2	IWFB2***	1692	2
315-630A	Size - 3	IWFB3***	2144	2

SWITCH DISCONNECTOR FUSES

HSN Code: 8536

Rated Current	Type	IN OPEN EXECUTION*		IN SHEET STEEL ENCLOSURE		Recommended HRC Fuse Indo Asian Make
		Cat Ref.	Unit Price (₹)	Cat Ref.	Unit Price (₹)	
32A BS	TPN	INO1A032	2232	INS1A032	4554	FSA
63A BS	TPN	INO1A063	3088	INS1A063	5802	FSS
100A BS	TPN	INO1A100	6788	INS1A100	9496	FSDCP
125A BS	TPN	INO1A125	7616	INS1A125	11380	FSDCP
160A BS	TPN	INO1A160	9218	INS1A160	12708	FSDCP
200A BS	TPN	INO1A200	11472	INS1A200	14782	FSF
250A BS	TPN	INO1A250	12948	INS1A250	17092	FSF
315A BS	TPN	INO1A315	16592	INS1A315	21338	FSK
400A BS	TPN	INO1A400	20594	INS1A400	25470	FMF
32A BS	TPSN	INO1B032	2838	INS1B032	4804	FSA
63A BS	TPSN	INO1B063	3602	INS1B063	5682	FSS
100A BS	TPSN	INO1B100	8346	INS1B100	10632	FSDCP
125A BS	TPSN	INO1B125	9140	INS1B125	11380	FSDCP
160A BS	TPSN	INO1B160	11432	INS1B160	14708	FSDCP
200A BS	TPSN	INO1B200	13020	INS1B200	16276	FSF
250A BS	TPSN	INO1B250	14196	INS1B250	18274	FSF
315A BS	TPSN	INO1B315	20088	INS1B315	25524	FSK
400A BS	TPSN	INO1B400	23764	INS1B400	26548	FMF

* Price Does Not Include HRC Fuse

HSN Code: 8536

Rated Current	Type	IN OPEN EXECUTION*		IN SHEET STEEL ENCLOSURE		Recommended HRC Fuse Indo Asian Make
		Cat Ref.	Unit Price (₹)	Cat Ref.	Unit Price (₹)	
32A DIN	TPN	IN1OA032	2346	IN1SA032	4334	Size 000
63A DIN	TPN	IN1OA063	3252	IN1SA063	5508	Size 000
100A DIN	TPN	IN1OA100	6958	IN1SA100	9392	Size 00
125A DIN	TPN	IN1OA125	7950	IN1SA125	11348	Size 00
160A DIN	TPN	IN1OA160	9566	IN1SA160	12466	Size 00
200A DIN	TPN	IN1OA200	11946	IN1SA200	14190	Size 01
250A DIN	TPN	IN1OA250	13380	IN1SA250	17080	Size 01
315A DIN	TPN	IN1OA315	17190	IN1SA315	21262	Size 02
400A DIN	TPN	IN1OA400	21190	IN1SA400	25202	Size 02
630A DIN	TPN	IN1OA630	33374	IN1SA630	35944	Size 03
800A DIN	TPN	IN1OA800	40694	IN1SA800	50882	Size 03
32A DIN	TPSN	IN1OB032	3322	IN1SB032	4460	Size 000
63A DIN	TPSN	IN1OB063	3832	IN1SB063	4816	Size 000
100A DIN	TPSN	IN1OB100	8584	IN1SB100	9606	Size 00
125A DIN	TPSN	IN1OB125	9512	IN1SB125	10342	Size 00
160A DIN	TPSN	IN1OB160	11146	IN1SB160	13826	Size 00
200A DIN	TPSN	IN1OB200	12952	IN1SB200	14584	Size 01
250A DIN	TPSN	IN1OB250	14834	IN1SB250	16708	Size 01
315A DIN	TPSN	IN1OB315	19854	IN1SB315	22736	Size 02
400A DIN	TPSN	IN1OB400	23074	IN1SB400	28388	Size 02
630A DIN	TPSN	IN1OB630	37042	IN1SB630	38830	Size 03
800A DIN	TPSN	IN1OB800	42832	IN1SB800	55968	Size 03

* Price Does Not Include HRC Fuse

SWITCH DISCONNECTOR 4 POLE

HSN Code: 8536

Rated Current	IN OPEN EXECUTION*		IN SHEET STEEL ENCLOSURE	
	Cat Ref.	Unit Price (₹)	Cat Ref.	Unit Price (₹)
400A	IN1SD400	16886	IN3ED400	26710
630A	IN1SD630	23434	IN4ED630	38966
800A	IN1SD800	27910	IN4ED800	45134

*Prices of 3 Pole SD is available on Request.

**Ambidex CHANGEOVER SWITCHES
ON-LOAD CHANGEOVER SWITCHES 4 POLE**

HSN Code: 8536

Rated Current	IN OPEN EXECUTION		IN SHEET STEEL ENCLOSURE	
	Cat Ref.	Unit Price (₹)	Cat Ref.	Unit Price (₹)
400A	ICAE0400	36572	ICAS0400	57450
630A	ICAE0630	43084	ICAS0630	61564
800A	ITAE0800	60380	ITAS0800	90630
1000A	ITAE1000	109224	ITAS1000	151894
1250A	ITAE1250	146584	ITAS1250	209698
1600A	ITAE1600	168318	ITAS1600	278244
2000A	ITAE2000	246138	ITAS2000	342826
2500A	ITAE2500	338634	ITAS2500	454738
3150A	ITAE3150	348024	ITAS3150	590320



HSN Code: 8536

ACCESSORIES FOR AMBIDEX CHANGEOVER SWITCHES	Cat Ref.	Unit Price (₹)
Auxiliary Switch 200A-630A (1NO + 1NC)	ICA00AUX	252
Spreader Links for Frame00 - 1 set (4 links)	ICA00SPL	396

ON-LOAD SWITCH FUSE CHANGEOVER

HSN Code: 8536

Rated Current	IN OPEN EXECUTION		IN SHEET STEEL ENCLOSURE		Recommended HRC Fuse Indo Asian Make
	Cat Ref.	Unit Price (₹)	Cat Ref.	Unit Price (₹)	
125A	ITBE0125	17054	ITBS0125	26062	FSDCP
200A	ITBE0200	31160	ITBS0200	46262	FSF
250A	ITBE0250	31454	ITBS0250	46692	FSK
320A	ITBE0320	32472	ITBS0320	48210	FSK
400A	ITBE0400	47032	ITBS0400	69828	FTS
630A	ITBE0630	54892	ITBS0630	81498	FTS

Price does not include HRC Fuses.

ON-LOAD BY-PASS SWITCHES

HSN Code: 8536

Rated Current	IN OPEN EXECUTION		IN SHEET STEEL ENCLOSURE	
	Cat Ref.	Unit Price (₹)	Cat Ref.	Unit Price (₹)
125A	ITCE0125	24262	ITCS0125	32760
200A	ITCE0200	30894	ITCS0200	41708
250A	ITCE0250	44882	ITCS0250	60588
320A	ITCE0320	46602	ITCS0320	62914
400A	ITCE0400	69902	ITCS0400	94370
630A	ITCE0630	79414	ITCS0630	107216



OFF LOAD CHANGEOVER SWITCH

HSN Code: 8536

 <ul style="list-style-type: none"> • With enclosure • Rated Voltage - 415V-AC 50Hz • Type - FP 	Rating	Cat Ref.	Unit Price (₹)
	32A (DP)	OFDP0032	2198
	16A	OFFP0016	3520
	32A	OFFP0032	3674
	63A	OFFP0063	7468
	100A	OFFP0100	14594
	125A	OFFP0125	20516
	200A	OFFP0200	22150
	250A	OFFP0250	28216
	315A	OFFP0315	29128
	400A	OFFP0400	33980

Prices for spares of Rewirable Switch Fuse Unit like Action Bar, Base Plate, End Shield, Bakelite Contact Shrouds are available on request.

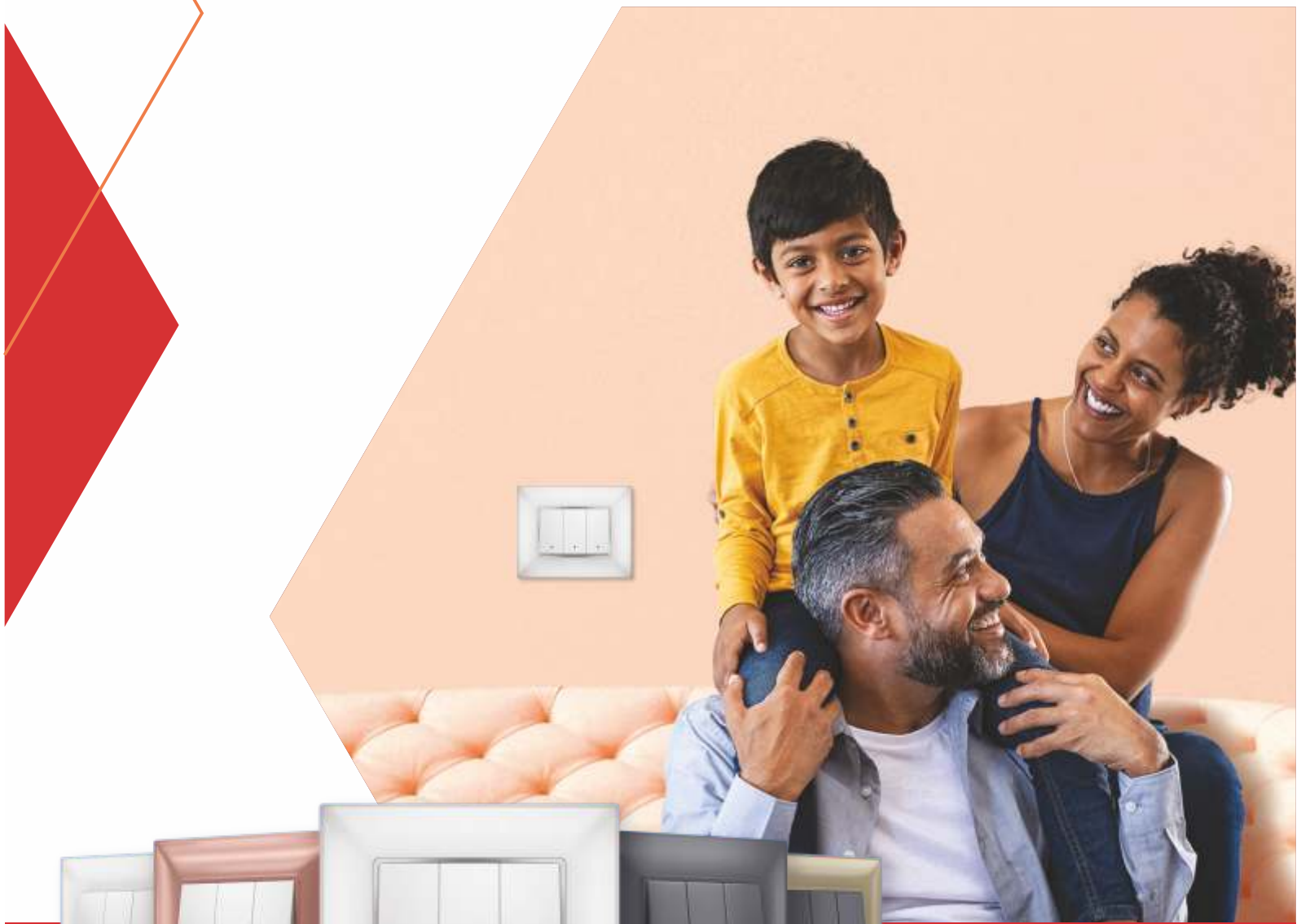

Add a touch of shine to your life.

Shynora

Aap Ki Shine
SWITCH & SOCKET



5 COLOUR
FINISHES



HIGH-GRADE
POLYCARBONATE



ROHS
COMPLIANT



FIRE
RETARDANT



ISI
MARK



CRS
CERTIFIED

Shynora

WHITE MECHANISMS

SWITCHES: • Polycarbonate Material* • LED Based Indicator • Shrouded Terminal • ISI Marked

SWITCHES 6A 230 V AC

HSN Code: 8536

	Cat. Nos.	Description	Module	Unit Price (₹)	Pack
	810600	6A 1 Way Switch	1	46	1/20/400
	810610	6A 2 Way Switch	1	90	1/20/200
	810602	6A 1 Way Switch with Indicator	1	92	1/20/200
	810604	6A 1 Way Switch with "Light" Marking	1	92	1/20/200
	810605	6A 1Way Switch with "Fan" Marking	1	92	1/20/200

SWITCHES 10A 230 V AC

HSN Code: 8536

	Cat. Nos.	Description	Module	Unit Price (₹)	Pack
	810673	10A 1 Way Switch	1	48	1/20/200
	810674	10A 2 Way Switch	1	96	1/20/200
	810675	10A 1 Way Switch with Indicator	1	94	1/20/200

SWITCHES 16A 230 V AC

HSN Code: 8536

	Cat. Nos.	Description	Module	Unit Price (₹)	Pack
	810601	16A 1 Way Switch	1	114	1/20/200
	810611	16A 2 Way Switch	1	154	1/10/100
	810603	16A 1 Way Switch with Indicator	1	138	1/20/200

SWITCHES 20A 230 V AC

HSN Code: 8536

	Cat. Nos.	Description	Module	Unit Price (₹)	Pack
	810606	20A 1 Way Switch	1	152	1/20/200
	810607	20A 1 Way Switch with Indicator	1	176	1/20/200
	810609	20A SP 1 Way Switch	2	218	1/10/100
	810612	20A DP Switch with Indicator	2	198	1/10/100

SWITCHES 25A 230 V AC

HSN Code: 8536

	Cat. Nos.	Description	Module	Unit Price (₹)	Pack
	810608	25A 1 Way Switch with Indicator	1	206	1/20/200

SWITCHES 32A 230 V AC

HSN Code: 8536

	Cat. Nos.	Description	Module	Unit Price (₹)	Pack
	810613	32A DP Switch with Indicator	2	272	1/10/100

BELL PUSH BUTTON 6A 230 V AC

HSN Code: 8536

	Cat. Nos.	Description	Module	Unit Price (₹)	Pack
	810615	6A Bell Push Switch	1	96	1/20/200
	810616	6A Bell Push Switch with Indicator	1	100	1/20/200
	810617	6A Bell Push Switch with Indicator	2	156	1/10/100

ACCESSORIES FOR SWITCHES

HSN Code: 8536

	Cat. Nos.	Description	Module	Unit Price (₹)	Pack
	810650	LED Indicator for Switches (Red)	-	38	1/5/25

Shynora

SOCKET 240 V AC • Child Safety Shutter • Shrouded Terminals • Smooth Plug Removal & Insertion

HSN Code: 8536

	Cat. Nos.	Description	Module	Unit Price (₹)	Pack
	810620	6A 3 Pin Round Socket with Shutter (ISI mark)	2	116	1/20/200
	810621	6A/16A 3 Pin Socket with Shutter (ISI mark)	2	220	1/10/100

DIMMERS AND FAN REGULATORS • Laser Marking

HSN Code: 8538 & 8414

	Cat. Nos.	Description	Module	Unit Price (₹)	Pack
	810641	Light Dimmer -400W	1	416	1/10/100
	810642	Light Dimmer -500W	2	534	1/10/100
	810638	Fan 4 Step Regulator 100W (ISI mark)	1	394	1/10/100
	810639	Fan Step Regulator 360 deg 100W (ISI mark)	2	512	1/10/100
	810640	Fan 8 Step Regulator 100W	2	600	1/10/100

SKIRTING LIGHT

HSN Code: 9405

	Cat. Nos.	Description	Module	Unit Price (₹)	Pack
	810649	Skirting Light	2	400	1/5/50

INDICATOR

HSN Code: 8536

	Cat. Nos.	Description	Module	Unit Price (₹)	Pack
	810645	Flat Indicator Red	1	120	1/20/200

BELL CALL INDICATOR

HSN Code: 8536

	Cat. Nos.	Description	Module	Unit Price (₹)	Pack
	810644	Bell Call Indicator	1	684	1/20/100

BUZZER

HSN Code: 8536

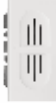
	Cat. Nos.	Description	Module	Unit Price (₹)	Pack
	810637	Buzzer -230V	1	292	1/20/100

**HOSPITALITY FUNCTION
HOTEL KEYCARD SWITCH**

HSN Code: 8538

	Cat. Nos.	Description	Module	Unit Price (₹)	Pack
	810614	32A DP Keytag Switch (Mechanical)	2	466	1/10
	810678	Keytag for (810614) NEW		222	1/10/100
	810646	Key Card SW 15A + Key Fob	2	2,406	1/10

Shynora

HOSPITALITY FUNCTION HOTEL "DND AND MMR"

HSN Code: 8538

	Cat. Nos.	Description	Module	Unit Price (₹)	Pack
	810647	DND Internal Unit	2	314	1/10/100
	810648	DND External Unit	2	372	1/10/100

SHAVER SOCKET

HSN Code: 8538

	Cat. Nos.	Description	Module	Unit Price (₹)	Pack
	810666	Shaver Socket	4	4,240	1/5/20

SOCKETS AND CONNECTORS

TV SOCKETS

HSN Code: 8536

	Cat. Nos.	Description	Module	Unit Price (₹)	Pack
	810633	TV Socket	1	108	1/20/200

DATA & VOICE

HSN Code: 8536

	Cat. Nos.	Description	Module	Unit Price (₹)	Pack
	810631	Telephone Socket - RJ11 with Shutter	1	106	1/20/200
	810632	Computer Socket - RJ45 Cat 6 with Shutter	1	624	1/20/200

SOUND - ELECTRONIC BELL

HSN Code: 8536

	Cat. Nos.	Description	Module	Unit Price (₹)	Pack
	810643	Electronic Bell	2	278	1/10/100

PROTECTORS AND ACCESSORIES

MOTOR STARTER

HSN Code: 8536

	Cat. Nos.	Description	Module	Unit Price (₹)	Pack
	810664	16A Motor Starter	2	556	10/50
	810665	25A Motor Starter	2	556	10/50

MODULAR MCB (IS : 608981:2002) • ISI Mark

HSN Code: 8536

	Cat. Nos.	Description	Module	Unit Price (₹)	Pack
	810654	6A Mini MCB SP C Curve	1	422	1/1/100
	810655	10A Mini MCB SP C Curve	1	422	1/1/100
	810656	16A Mini MCB SP C Curve	1	422	1/1/100
	810657	20A Mini MCB SP C Curve	1	422	1/1/100
	810658	25A Mini MCB SP C Curve	1	422	1/1/100
	810659	32A Mini MCB SP C Curve	1	422	1/1/100
	810660	16A Mini MCB DP C Curve	2	746	1/1/100
	810661	20A Mini MCB DP C Curve	2	746	1/1/100
	810662	25A Mini MCB DP C Curve	2	746	1/1/100
	810663	32A Mini MCB DP C Curve	2	746	1/1/100



NEW!!

NEW!!



Shynora

Aap Ki Shine
USB CHARGERS

Effortless Charging, Simplified Living



3.0A CHARGING (MAX)



TYPE C USB



TYPE A USB

2 IN 1 CHARGING



CRS CERTIFIED



ROHS COMPLIANT



20W PD FAST CHARGING

Shynora

PROTECTORS AND ACCESSORIES

POWER UNIT

HSN Code: 8536

	Cat. Nos.	Description	Module	Unit Price (₹)	Pack
	810625	Power Unit with 20A MCB & 16A Plug	3	1,002	1/10
810626	Power Unit with 25A MCB & 16A Plug	3	1,074	1/10	

ELECTRONIC FUNCTION

USB CHARGERS (IS13252 (PART 1) / IEC 60950-1) • CRS Certified

HSN Code: 8536

	Cat. Nos.	Description	Module	Unit Price (₹)	Pack
	810652	USB Charger 1500mA Type A	1	934	1/10/100
810651	Double USB Charger 3000mA Type A + A	2	1,496	1/10/100	
810676	USB Charger Type C 20W PD* NEW	1	2,534	1/10/100	
810677	USB Charger 3000mA, 15W Type A + C* NEW	1	1,908	1/10/100	
810669	Double USB Charger 3000mA, 15W Type A + C	2	1,700	1/10/100	

* Will be launched soon

ACCESSORIES

HSN Code: 8538

	Cat. Nos.	Description	Module	Unit Price (₹)	Pack
	810667	1 Module Blank Plate	1	28	1/40/400
810668	Cable Outlet	1	86	1/20/100	

Shynora

COOL GREY MECHANISMS

SWITCHES: • Polycarbonate Material* • LED Based Indicator • Shrouded Terminal • ISI Marked

SWITCHES 6A 230 V AC

HSN Code: 8536

	Cat. Nos.	Description	Module	Unit Price (₹)	Pack
	810700	6A 1 Way Switch	1	54	1/20/400
810710	6A 2 Way Switch	1	104	1/20/200	
810702	6A 1 Way Switch with Indicator	1	98	1/20/200	
810704	6A 1 Way Switch with "Light" Marking	1	108	1/20/200	
810705	6A 1 Way Switch with "Fan" Marking	1	108	1/20/200	

SWITCHES 16A 230 V AC

HSN Code: 8536

	Cat. Nos.	Description	Module	Unit Price (₹)	Pack
	810701	16A 1 Way Switch	1	138	1/20/200
810711	16A 2 Way Switch	1	186	1/10/100	
810703	16A 1 Way Switch with Indicator	1	148	1/20/200	

SWITCHES 20A 230 V AC

HSN Code: 8536

	Cat. Nos.	Description	Module	Unit Price (₹)	Pack
	810706	20A 1 Way Switch	1	178	1/20/200
810707	20A 1 Way Switch with Indicator	1	204	1/20/200	
810709	20A SP 1 Way Switch	2	252	1/10/100	
810712	20A DP Switch with Indicator	2	226	1/10/100	

Shynora

SWITCHES 25A 230 V AC

HSN Code: 8536

	Cat. Nos.	Description	Module	Unit Price (₹)	Pack
	810708	25A 1 Way Switch with Indicator	1	224	1/20/200

SWITCHES 32A 230 V AC

HSN Code: 8536

	Cat. Nos.	Description	Module	Unit Price (₹)	Pack
	810713	32A DP Switch with Indicator	2	314	1/10/100

BELL PUSH BUTTON 6A 230 V AC

HSN Code: 8536

	Cat. Nos.	Description	Module	Unit Price (₹)	Pack
	810715	6A Bell Push Switch	1	114	1/20/200
	810716	6A Bell Push Switch with Indicator	1	124	1/20/200
	810717	6A Bell Push Switch with Indicator	2	180	1/10/100

SOCKET 240 V AC • Child Safety Shutter • Shrouded Terminals • Smooth Plug Removal & Insertion

HSN Code: 8536

	Cat. Nos.	Description	Module	Unit Price (₹)	Pack
	810720	6A 3 Pin Round Socket with Shutter (ISI mark)	2	138	1/20/200
	810721	6A/16A 3 Pin Socket with Shutter (ISI Mark)	2	254	1/10/100

DIMMERS AND FAN REGULATORS • Laser Marking

HSN Code: 8538 & 8414

	Cat. Nos.	Description	Module	Unit Price (₹)	Pack
	810741	Light Dimmer -400W	1	476	1/10/100
	810742	Light Dimmer -500W	2	626	1/10/100
	810738	Fan 4 Step Regulator 100W (ISI mark)	1	456	1/10/100
	810739	Fan Step Regulator 360 deg 100W (ISI mark)	2	600	1/10/100
	810740	Fan 8 Step Regulator 100W	2	724	1/10/100

SKIRTING LIGHT

HSN Code: 9405

	Cat. Nos.	Description	Module	Unit Price (₹)	Pack
	810749	Skirting Light	2	436	1/5/50

INDICATOR

HSN Code: 8536

	Cat. Nos.	Description	Module	Unit Price (₹)	Pack
	810745	Flat Indicator Red	1	128	1/20/200

BUZZER

HSN Code: 8536

	Cat. Nos.	Description	Module	Unit Price (₹)	Pack
	810737	Buzzer -230V	1	336	1/20/100

Shynora

HOSPITALITY FUNCTION HOTEL KEYCARD SWITCH

HSN Code: 8538

	Cat. Nos.	Description	Module	Unit Price (₹)	Pack
	810714	32A DP Keytag Switch (Mechanical)	2	538	1/10
	810778	Keytag for (810714) NEW		258	1/10/100
	810746	Key Card SW 15A + Key Fob	2	3,076	1/10

HOTEL "DND AND MMR"

HSN Code: 8538

	Cat. Nos.	Description	Module	Unit Price (₹)	Pack
	810747	DND Internal Unit	2	386	1/10/100
	810748	DND External Unit	2	438	1/10/100

SHAVER SOCKET

HSN Code: 8538

	Cat. Nos.	Description	Module	Unit Price (₹)	Pack
	810766	Shaver Socket	4	5,322	1/5/20

SOCKETS AND CONNECTORS

TV SOCKETS

HSN Code: 8536

	Cat. Nos.	Description	Module	Unit Price (₹)	Pack
	810733	TV Socket	1	126	1/20/200

DATA & VOICE

HSN Code: 8536

	Cat. Nos.	Description	Module	Unit Price (₹)	Pack
	810731	Telephone Socket - RJ11 with Shutter	1	124	1/20/200
	810732	Computer Socket- RJ45 Cat 6 with Shutter	1	726	1/20/200

PROTECTORS AND ACCESSORIES

MOTOR STARTER

HSN Code: 8536

	Cat. Nos.	Description	Module	Unit Price (₹)	Pack
	810764	16A Motor Starter	2	654	10/50
	810765	25A Motor Starter	2	654	10/50

Shynora

PROTECTORS AND ACCESSORIES

MODULAR MCB (IS : 608981:2002) • ISI Mark

HSN Code: 8536

	Cat. Nos.	Description	Module	Unit Price (₹)	Pack
	810754	6A Mini MCB SP C Curve	1	486	1/1/100
	810755	10A Mini MCB SP C Curve	1	486	1/1/100
	810756	16A Mini MCB SP C Curve	1	486	1/1/100
	810757	20A Mini MCB SP C Curve	1	486	1/1/100
	810758	25A Mini MCB SP C Curve	1	486	1/1/100
	810759	32A Mini MCB SP C Curve	1	486	1/1/100

POWER UNIT

HSN Code: 8536

	Cat. Nos.	Description	Module	Unit Price (₹)	Pack
	810725	Power Unit with 20A MCB & 16A Plug	3	1,166	1/10
	810726	Power Unit with 25A MCB & 16A Plug	3	1,254	1/10

ELECTRONIC FUNCTION

USB CHARGERS (IS13252 (PART 1) / IEC 60950-1) • CRS Certified

HSN Code: 8536

	Cat. Nos.	Description	Module	Unit Price (₹)	Pack
	810752	USB Charger 1500mA Type A	1	1,168	1/10/100
	810751	Double USB Charger 3000mA Type A + A	2	1,728	1/10/100
	810776	USB Charger Type C 20W PD* NEW	1	2,860	1/10/100
	810777	USB Charger 3000mA, 15W Type A + C* NEW	1	2,068	1/10/100
	810769	Double USB Charger 3000mA, 15W Type A + C	2	1,936	1/10/100

* Will be launched soon

ACCESSORIES

HSN Code: 8538



	Cat. Nos.	Description	Module	Unit Price (₹)	Pack
	810767	1 Module Blank Plate	1	32	1/40/400
	810768	Cable Outlet	1	92	1/20/100

PLATE & FRAME • Strong Dimensional Stability

WHITE MODULAR PLATE WITH SUPPORT FRAME

HSN Code: 8538

	Cat. Nos.	Description	Module	Unit Price (₹)	Pack
	810800	White Plate + Frame, 1 module	1	88	1/10/100
	810801	White Plate + Frame, 2 module	2	88	1/10/100
	810802	White Plate + Frame, 3 module	3	130	1/10/100
	810803	White Plate + Frame, 4 module	4	138	1/10/100
	810804	White Plate + Frame, 6 module	6	192	1/10/100
	810805	White Plate + Frame, 8 module	8	248	1/10/100
	810806	White Plate + Frame, 2X4 module	8	248	1/5/25
	810807	White Plate + Frame, 9 module	9	276	1/5/50
	810808	White Plate + Frame, 12 module	12	326	1/5/25
	810809	White Plate + Frame, 16 module	16	372	1/5/25
	810810	White Plate + Frame, 18 module	18	436	1/5/25

Shynora

COOL GREY MODULAR PLATE WITH SUPPORT FRAME

HSN Code: 8538

	Cat. Nos.	Description	Module	Unit Price (₹)	Pack
	810811	Cool Grey Plate + Frame, 1 module	1	108	1/10/100
	810812	Cool Grey Plate + Frame, 2 module	2	108	1/10/100
	810813	Cool Grey Plate + Frame, 3 module	3	158	1/10/100
	810814	Cool Grey Plate + Frame, 4 module	4	170	1/10/100
	810815	Cool Grey Plate + Frame, 6 module	6	238	1/10/100
	810816	Cool Grey Plate + Frame, 8 module	8	274	1/10/100
	810817	Cool Grey Plate + Frame, 2X4 module	8	274	1/5/25
	810818	Cool Grey Plate + Frame, 9 module	9	338	1/5/50
	810819	Cool Grey Plate + Frame, 12 module	12	396	1/5/25
	810820	Cool Grey Plate + Frame, 16 module	16	446	1/5/25
810821	Cool Grey Plate + Frame, 18 module	18	538	1/5/25	

CHROME MODULAR PLATE WITH SUPPORT FRAME

HSN Code: 8538

	Cat. Nos.	Description	Module	Unit Price (₹)	Pack
	810833	Chrome Plate + Frame, 1 module	1	98	1/10/100
	810834	Chrome Plate + Frame, 2 module	2	98	1/10/100
	810835	Chrome Plate + Frame, 3 module	3	136	1/10/100
	810836	Chrome Plate + Frame, 4 module	4	160	1/10/100
	810837	Chrome Plate + Frame, 6 module	6	222	1/10/100
	810838	Chrome Plate + Frame, 8 module	8	258	1/10/100
	810839	Chrome Plate + Frame, 2X4 module	8	258	1/5/25
	810840	Chrome Plate + Frame, 9 module	9	320	1/5/50
	810841	Chrome Plate + Frame, 12 module	12	368	1/5/25
	810842	Chrome Plate + Frame, 16 module	16	424	1/5/25
	810843	Chrome Plate + Frame, 18 module	18	506	1/5/25

PINK MODULAR PLATE WITH SUPPORT FRAME

HSN Code: 8538

	Cat. Nos.	Description	Module	Unit Price (₹)	Pack
	810844	Pink Plate + Frame, 1 module	1	120	1/10/100
	810845	Pink Plate + Frame, 2 module	2	120	1/10/100
	810846	Pink Plate + Frame, 3 module	3	164	1/10/100
	810847	Pink Plate + Frame, 4 module	4	190	1/10/100
	810848	Pink Plate + Frame, 6 module	6	270	1/10/100
	810849	Pink Plate + Frame, 8 module	8	332	1/10/100
	810850	Pink Plate + Frame, 2X4 module	8	332	1/5/25
	810851	Pink Plate + Frame, 9 module	9	392	1/5/50
	810852	Pink Plate + Frame, 12 module	12	448	1/5/25
	810853	Pink Plate + Frame, 16 module	16	562	1/5/25
	810854	Pink Plate + Frame, 18 module	18	610	1/5/25

Shynora

MILAN GOLD MODULAR PLATE WITH SUPPORT FRAME

HSN Code: 8538

	Cat. Nos.	Description	Module	Unit Price (₹)	Pack
	810855	Milan Gold Plate + Frame, 1 module	1	120	1/10/100
	810856	Milan Gold Plate + Frame, 2 module	2	120	1/10/100
	810857	Milan Gold Plate + Frame, 3 module	3	164	1/10/100
	810858	Milan Gold Plate + Frame, 4 module	4	190	1/10/100
	810859	Milan Gold Plate + Frame, 6 module	6	270	1/10/100
	810860	Milan Gold Plate + Frame, 8 module	8	332	1/10/100
	810861	Milan Gold Plate + Frame, 2X4 module	8	332	1/5/25
	810862	Milan Gold Plate + Frame, 9 module	9	392	1/5/50
	810863	Milan Gold Plate + Frame, 12 module	12	448	1/5/25
	810864	Milan Gold Plate + Frame, 16 module	16	562	1/5/25
810865	Milan Gold Plate + Frame, 18 module	18	610	1/5/25	

METAL FLUSH BOX • Made of G.I. Sheet • Earth Terminal for Safety • Provision for Knockouts Available

HSN Code: 8538

	Cat. Nos.	Description	Module	Unit Price (₹)	Pack
	800172	Metal Flush Box, 1/2 Module	1/2	70	40
	800173	Metal Flush Box, 3 Module	3	90	40
	800174	Metal Flush Box, 4 Module	4	106	40
	800176	Metal Flush Box, 6 Module	6	160	20
	800177	Metal Flush Box, 8 Module (vertical)	8	206	20
	800178	Metal Flush Box, 8 Module	8	206	20
	810867	Metal Flush Box, 9 Module	9	246	20
	800175	Metal Flush Box, 12 Module	12	270	10
	800179	Metal Flush Box, 16 Module	16	310	10
	800180	Metal Flush Box, 18 Module	18	338	10

PLASTIC SURFACE BOX • Flame Retardant Material • Edge to Edge Fitting with Plate • ISI Marked

HSN Code: 8538

	Cat. Nos.	Description	Module	Unit Price (₹)	Pack
	800182	Plastic Surface Box, 1/2 Module	1/2	72	50
	800183	Plastic Surface Box, 3 Module	3	90	35
	800184	Plastic Surface Box, 4 Module	4	102	25
	800186	Plastic Surface Box, 6 Module	6	156	10
	800187	Plastic Surface Box, 8 Module (vertical)	8	212	15
	810866	Plastic Surface Box, 8 Module White	8	224	10
	800185	Plastic Surface Box, 12 Module	12	268	10
	800189	Plastic Surface Box, 16 Module	16	312	10
	800190	Metal Surface Box, 18 Module	18	348	10

Cover Plates - Shynora

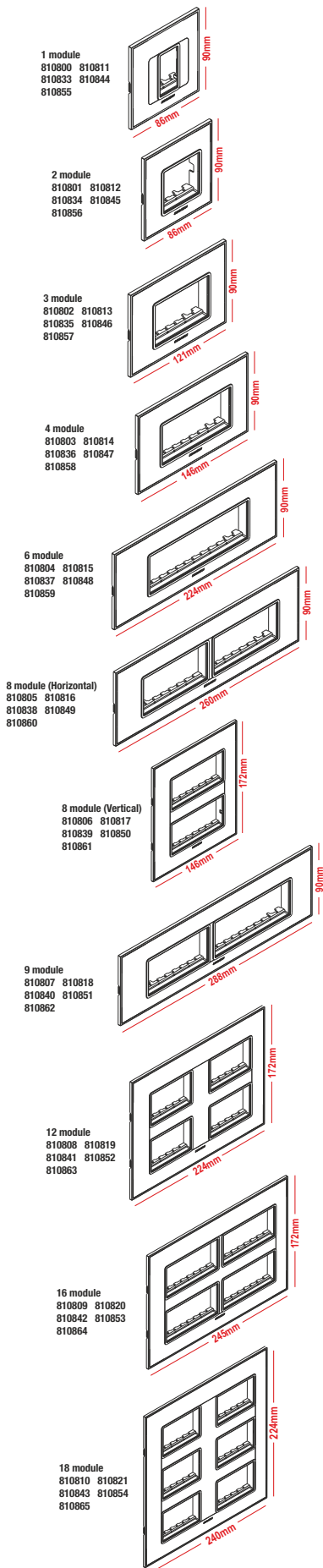

Flush Boxes-Metal

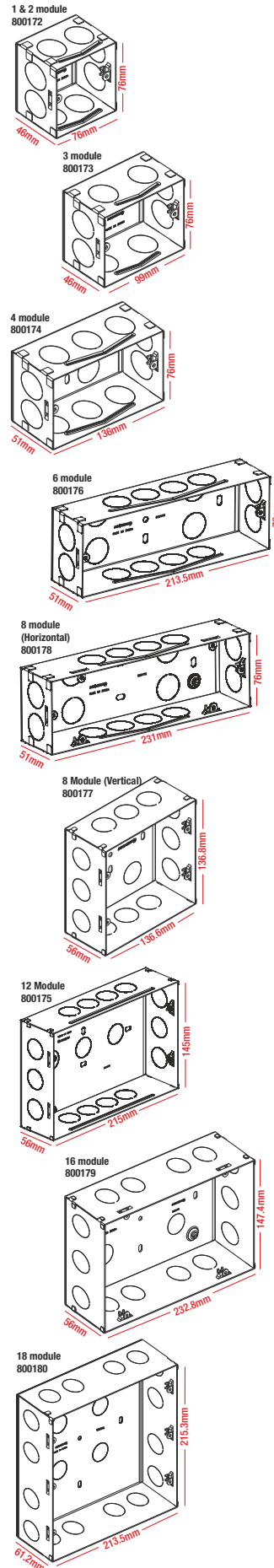

Surface Boxes-Plastic

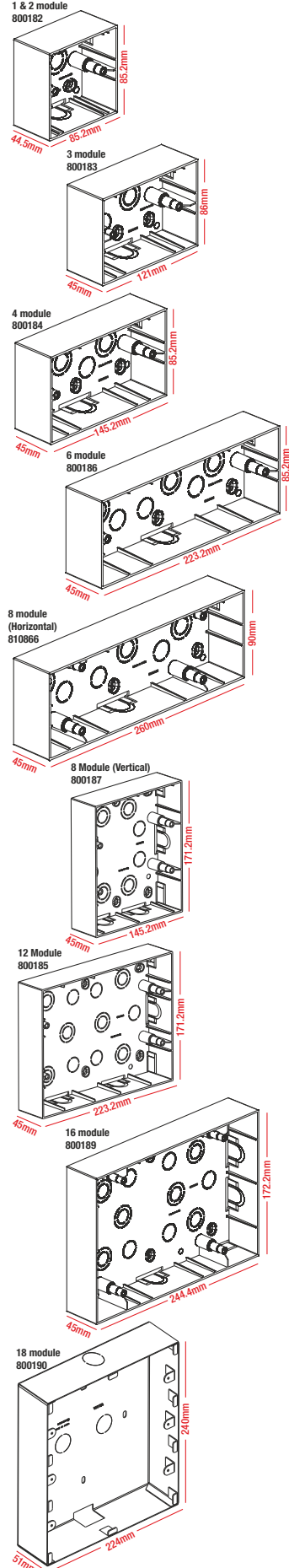



Glint[™]
Welcome Change
SWITCH & SOCKET

Add the Elegance of Colour to Your Space!



4 METALLIC COLOR
PLATE FINISHES



SUITABLE FOR FLUSH
AND WOODEN BOXES



ROHS COMPLIANT



FIRE RETARDANT



ISI MARK

Glint™

WHITE MECHANISMS

SWITCHES: • Polycarbonate Material* • LED Based Indicator • ISI Marked

SWITCHES 6A 230 V AC

HSN Code: 8536

	Cat. Nos.	Description	Module	Unit Price (₹)	Pack
	800000	6A 1 Way Switch	1	36	1/20/400
	800001	6A 2 Way Switch	1	72	1/20/200

SWITCHES 16A 230 V AC

HSN Code: 8536

	Cat. Nos.	Description	Module	Unit Price (₹)	Pack
	800002	16A 1 Way Switch	1	96	1/20/200
	800003	16A 2 Way Switch	1	124	1/10/100
	800004	16A 1 way Switch with Indicator	1	120	1/10/100

SWITCHES 20A 230 V AC

HSN Code: 8536

	Cat. Nos.	Description	Module	Unit Price (₹)	Pack
	800005	20A DP Switch with Indicator	2	148	1/10/50

SWITCHES 25A 230V AC

HSN Code: 8536

	Cat. Nos.	Description	Module	Unit Price (₹)	Pack
	800089	25A Switch with Indicator	1	128	1/10/100

SWITCHES 32A 230 V AC

HSN Code: 8536

	Cat. Nos.	Description	Module	Unit Price (₹)	Pack
	800006	32A DP Switch with Indicator	2	216	1/10/50

BELL PUSH BUTTON 6A 230 V AC

HSN Code: 8536

	Cat. Nos.	Description	Module	Unit Price (₹)	Pack
	800007	6A Bell Push with Indicator	1	84	1/10/100
	800008	6A Bell Push with Indicator	2	126	1/10/100

SOCKET 240 V AC • Child Safety Shutter • Smooth Plug removal & insertion

HSN Code: 8536

	Cat. Nos.	Description	Module	Unit Price (₹)	Pack
	801800	6A 3 Pin Round Socket with Shutter (ISI mark)	2	70	1/20/200
	800022	6A/16A 3 Pin Socket with Shutter (ISI mark)	2	134	1/10/100

DIMMERS AND FAN REGULATORS • Laser Marking for Easy Identification

HSN Code: 8538 & 8414

	Cat. Nos.	Description	Module	Unit Price (₹)	Pack
	800042	Light Dimmer -400W	1	340	1/10/100
	800041	Fan 4 Step Regulator -100W	1	348	1/10/100
	800043	Fan 4 Step Regulator -100W	2	390	1/10/100
	800090	Fan 5 Step Regulator -100W (ISI mark)	2	346	1/10/100
	800091	Fan 8 Step Regulator -100W	2	346	1/10/100

Glint™
SKIRTING LIGHT

HSN Code: 8536

	Cat. Nos.	Description	Module	Unit Price (₹)	Pack
	800092	Skirting Light 2M	2	250	1/5/25

INDICATOR

HSN Code: 8536

	Cat. Nos.	Description	Module	Unit Price (₹)	Pack
	800033	Flat Indicator Red	1	100	1/10/100

BUZZER

HSN Code: 8536

	Cat. Nos.	Description	Module	Unit Price (₹)	Pack
	800040	Buzzer 230V	1	196	1/20/100

HOSPITALITY FUNCTION
HOTEL KEYCARD SWITCH

HSN Code: 8536

	Cat. Nos.	Description	Module	Unit Price (₹)	Pack
	800093	32A DP Keytag Switch (Mechanical)	2	342	1/10

HOTEL "DND AND MMR" FUNCTIONS

HSN Code: 8536

	Cat. Nos.	Description	Module	Unit Price (₹)	Pack
	800094	DND Internal Unit	2	126	1/10/100
	800095	DND External Unit	2	226	1/10/100

SOCKETS AND CONNECTORS

TV SOCKETS

HSN Code: 8536

	Cat. Nos.	Description	Module	Unit Price (₹)	Pack
	800032	TV Socket	1	70	1/20/100

DATA & VOICE

HSN Code: 8536

	Cat. Nos.	Description	Module	Unit Price (₹)	Pack
	800030	Telephone Socket - RJ11	1	76	1/20/100
	800031	Computer Socket- RJ45 Cat 6	1	176	1/20/100

PROTECTORS AND ACCESSORIES

MODULAR MCB (IS : 608981:2002) • Laser Marking

HSN Code: 8536

	Cat. Nos.	Description	Module	Unit Price (₹)	Pack
	800097	6A Mini MCB SP C Curve	1	218	1/10/100
	800098	10A Mini MCB SP C Curve	1	218	1/10/100
	800010	16A Mini MCB SP C Curve	1	330	1/10/100
	800011	20A Mini MCB SP C Curve	1	330	1/10/100
	800012	25A Mini MCB SP C Curve	1	330	1/10/100
	800013	32A Mini MCB SP C Curve	1	330	1/10/100

Glint™
MOTOR STARTER

HSN Code: 8536

	Cat. Nos.	Description	Module	Unit Price (₹)	Pack
	800096	25A MOTOR STARTER	2	360	1/10/50

ELECTRONIC FUNCTION
USB CHARGERS (IS13252 (PART 1) / IEC 60950-1) • CRS Certified

HSN Code: 8536

	Cat. Nos.	Description	Module	Unit Price (₹)	Pack
	800044	USB Charger 1500mA Type A	1	818	1/10/100

ACCESSORIES • Spare Screw Caps

HSN Code: 8538

	Cat. Nos.	Description	Module	Unit Price (₹)	Pack
	800051	1 Module Blank Plate	1	24	1/20/200
800052	2 Module Blank Plate	2	28	1/10/100	
800059	Screw Caps		24	1/10/100	

Glint™
WHITE GLINT PLATE

PLATE: • Unique Design - Sleek & Curvy • Flame Retardant Material • Compatible with Standard Size of Metal Flush & Plastic Surface Boxes **HSN Code: 8538**

	Cat. Nos.	Description	Module	Unit Price (₹)	Pack
	800061	1 Module Plate	1	54	1/10/100
	800062	2 Module Plate	2	54	1/10/100
	800063	3 Module Plate	3	76	1/10/100
	800064	4 Module Plate	4	90	1/10/100
	800066	6 Module Plate	6	112	1/5/50
	800067	8 Module Plate (Vertical)	8	158	1/5/25
	800068	8 Module Plate (Horizontal)	8	148	1/5/50
	800065	12 Module Plate	12	206	1/5/25
	800069	16 Module Plate	16	214	1/5/25
	800070	18 Module Plate	18	262	1/5/25

WHITE GLINT PLATE WITH FRAME

PLATE & FRAME: • Aesthetic Design • Suitable for Metal Flush & Wooden Boxes • Comes with Regular & Self Tapping Screws **HSN Code: 8538**

	Cat. Nos.	Description	Module	Unit Price (₹)	Pack
	800071	White Plate + Frame, 1M	1	80	1/10/100
	800072	White Plate + Frame, 2M	2	80	1/10/100
	800073	White Plate + Frame, 3M	3	102	1/10/100
	800074	White Plate + Frame, 4M	4	130	1/10/100
	800076	White Plate + Frame, 6M	6	162	1/10/50
	800078	White Plate + Frame, 8M (Vertical)	8	232	1/5/25
	800079	White Plate + Frame, 8M (Horizontal)	8	232	1/10/50
	800080	White Plate + Frame, 10M	10	274	1/5/25
	800082	White Plate + Frame, 12M (Vertical)	12	298	1/5/25
	800084	White Plate + Frame, 12M (Horizontal)	12	298	1/5/25
	800086	White Plate + Frame, 16M	16	338	1/5/25
	800088	White Plate + Frame, 18M	18	368	1/5/25

Glint™

METALLIC GREY GLINT PLATE WITH FRAME

HSN Code: 8538

	Cat. Nos.	Description	Module	Unit Price (₹)	Pack
	800241	Metallic Grey Plate + Frame, 1M	1	116	1/10/100
	800242	Metallic Grey Plate + Frame, 2M	2	116	1/10/100
	800243	Metallic Grey Plate + Frame, 3M	3	146	1/10/100
	800244	Metallic Grey Plate + Frame, 4M	4	182	1/10/100
	800245	Metallic Grey Plate + Frame, 6M	6	228	1/10/50
	800246	Metallic Grey Plate + Frame, 8M (Horizontal)	8	326	1/10/50
	800247	Metallic Grey Plate + Frame, 8M (Vertical)	8	326	1/5/25
	800248	Metallic Grey Plate + Frame, 10M	10	380	1/5/25
	800249	Metallic Grey Plate + Frame, 12M (Horizontal)	12	414	1/5/25
	800250	Metallic Grey Plate + Frame, 12M (Vertical)	12	414	1/5/25
	800251	Metallic Grey Plate + Frame, 16M	16	550	1/5/25
800252	Metallic Grey Plate + Frame, 18M	18	586	1/5/25	

METALLIC GOLD GLINT PLATE WITH FRAME

HSN Code: 8538

	Cat. Nos.	Description	Module	Unit Price (₹)	Pack
	800253	Metallic Gold Plate + Frame, 1M	1	116	1/10/100
	800254	Metallic Gold Plate + Frame, 2M	2	116	1/10/100
	800255	Metallic Gold Plate + Frame, 3M	3	146	1/10/100
	800256	Metallic Gold Plate + Frame, 4M	4	182	1/10/100
	800257	Metallic Gold Plate + Frame, 6M	6	228	1/10/50
	800258	Metallic Gold Plate + Frame, 8M (Horizontal)	8	326	1/10/50
	800259	Metallic Gold Plate + Frame, 8M (Vertical)	8	326	1/5/25
	800260	Metallic Gold Plate + Frame, 10M	10	380	1/5/25
	800261	Metallic Gold Plate + Frame, 12M (Horizontal)	12	414	1/5/25
	800262	Metallic Gold Plate + Frame, 12M (Vertical)	12	414	1/5/25
	800263	Metallic Gold Plate + Frame, 16M	16	550	1/5/25
800264	Metallic Gold Plate + Frame, 18M	18	586	1/5/25	

METALLIC PLUM GLINT PLATE WITH FRAME

HSN Code: 8538

	Cat. Nos.	Description	Module	Unit Price (₹)	Pack
	800265	Metallic Plum Plate + Frame, 1M	1	116	1/10/100
	800266	Metallic Plum Plate + Frame, 2M	2	116	1/10/100
	800267	Metallic Plum Plate + Frame, 3M	3	146	1/10/100
	800268	Metallic Plum Plate + Frame, 4M	4	182	1/10/100
	800269	Metallic Plum Plate + Frame, 6M	6	228	1/10/50
	800270	Metallic Plum Plate + Frame, 8M (Horizontal)	8	326	1/10/50
	800271	Metallic Plum Plate + Frame, 8M (Vertical)	8	326	1/5/25
	800272	Metallic Plum Plate + Frame, 10M	10	380	1/5/25
	800273	Metallic Plum Plate + Frame, 12M (Horizontal)	12	414	1/5/25
	800274	Metallic Plum Plate + Frame, 12M (Vertical)	12	414	1/5/25
	800275	Metallic Plum Plate + Frame, 16M	16	550	1/5/25
800276	Metallic Plum Plate + Frame, 18M	18	586	1/5/25	

Glint™

METALLIC MINT GLINT PLATE WITH FRAME

HSN Code: 8538

	Cat. Nos.	Description	Module	Unit Price (₹)	Pack
	800277	Metallic Mint Plate + Frame, 1M	1	116	1/10/100
	800278	Metallic Mint Plate + Frame, 2M	2	116	1/10/100
	800279	Metallic Mint Plate + Frame, 3M	3	146	1/10/100
	800280	Metallic Mint Plate + Frame, 4M	4	182	1/10/100
	800281	Metallic Mint Plate + Frame, 6M	6	228	1/10/50
	800282	Metallic Mint Plate + Frame, 8M (Horizontal)	8	326	1/10/50
	800283	Metallic Mint Plate + Frame, 8M (Vertical)	8	326	1/5/25
	800284	Metallic Mint Plate + Frame, 10M	10	380	1/5/25
	800285	Metallic Mint Plate + Frame, 12M (Horizontal)	12	414	1/5/25
	800286	Metallic Mint Plate + Frame, 12M (Vertical)	12	414	1/5/25
	800287	Metallic Mint Plate + Frame, 16M	16	550	1/5/25
	800288	Metallic Mint Plate + Frame, 18M	18	586	1/5/25

METAL FLUSH BOX • Made of G.I. Sheet • Earth Terminal for Safety • Provision for Knockouts Available

HSN Code: 8538

	Cat. Nos.	Description	Module	Unit Price (₹)	Pack
	800172	Metal Flush Box 1/2 Module	1/2	70	40
	800173	Metal Flush Box 3 Module	3	90	40
	800174	Metal Flush Box 4 Module	4	106	40
	800176	Metal Flush Box 6 Module	6	160	20
	800177	Metal Flush Box 8 Module (Vertical)	8	206	20
	800178	Metal Flush Box 8 Module	8	206	20
	810867	Metal Flush Box 9 Module	9	246	20
	800175	Metal Flush Box 12 Module	12	270	10
	800179	Metal Flush Box 16 Module	16	310	10
	800180	Metal Flush Box 18 Module	18	338	10

PLASTIC SURFACE BOX • Flame Retardant Material • Edge to Edge Fitting with Plate • ISI Marked

HSN Code: 8538

	Cat. Nos.	Description	Module	Unit Price (₹)	Pack
	800182	Plastic Surface Box 1/2 Module	1/2	72	50
	800183	Plastic Surface Box 3 Module	3	90	35
	800184	Plastic Surface Box 4 Module	4	102	25
	800186	Plastic Surface Box 6 Module	6	156	10
	800187	Plastic Surface Box 8 Module (Vertical)	8	212	15
	800188	Plastic Surface Box 8 Module	8	212	10
	800185	Plastic Surface Box 12 Module	12	268	10
	800189	Plastic Surface Box 16 Module	16	312	10
	800190	Metal Surface Box 18 Module	18	348	10

Cover Plates - Glint™

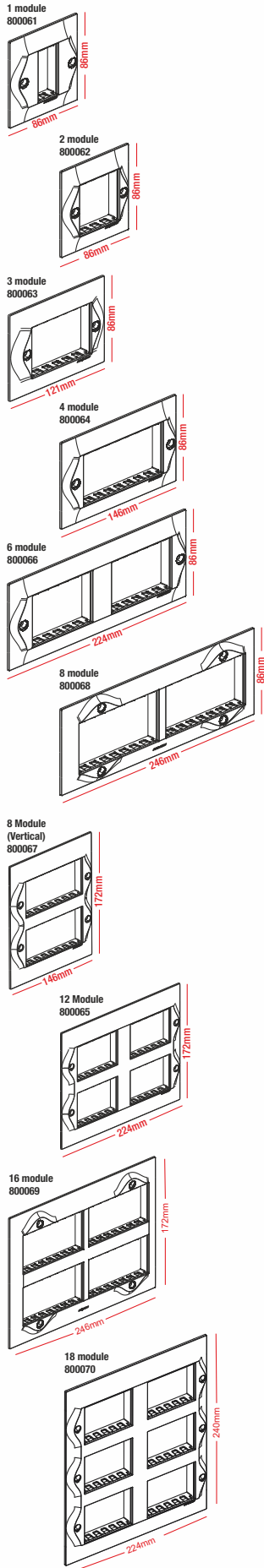

Flush Boxes-Metal

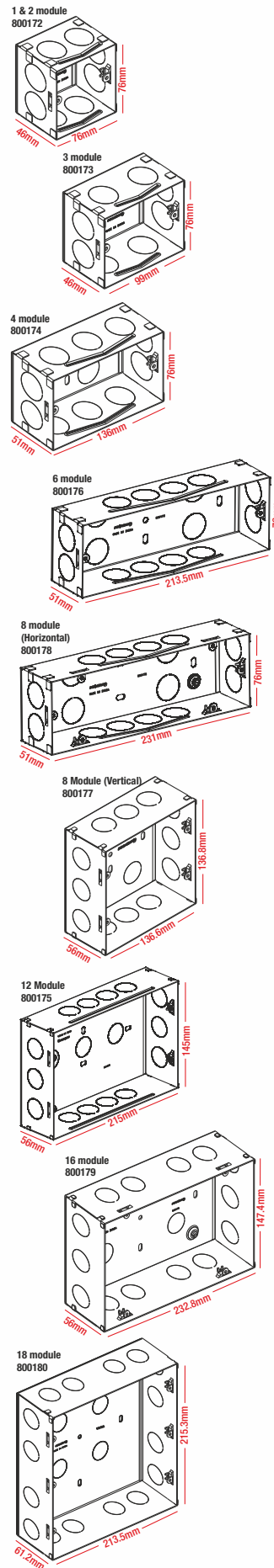

Surface Boxes-Plastic

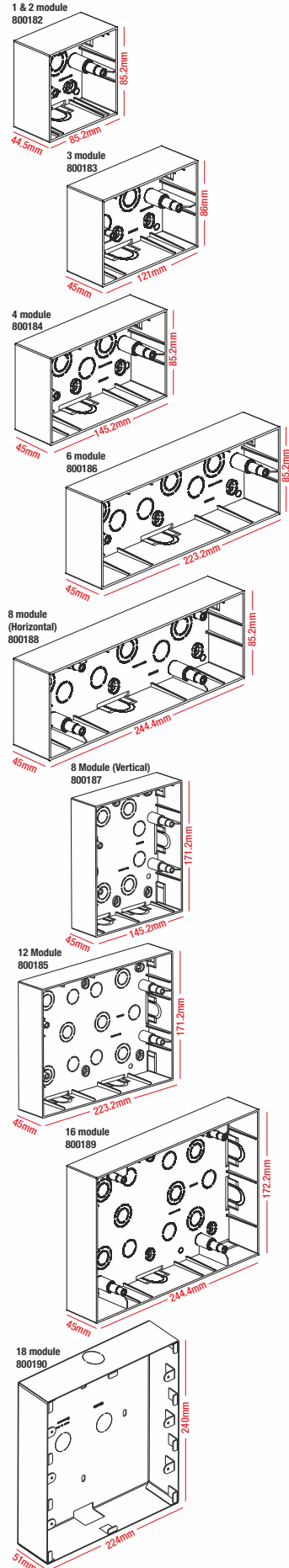



Colours that reflect your personality

ELVIRA

A SENSIBLE SWITCH
SWITCH & SOCKET



CONTEMPORARY
FINISHES



TRENDING
COLOURS



MORE RESISTANT
TO SCRATCHES AND FADING



ISI
MARK



ROHS
COMPLIANT

ELVIRA
A SENSIBLE SWITCH

WHITE MECHANISMS

SWITCHES: • Polycarbonate Material* • LED Based Indicator • ISI Marked

SWITCHES 6A 230 V AC

HSN Code: 8536

	Cat. Nos.	Description	Module	Unit Price (₹)	Pack
	800100	6A 1 way Switch	1	40	1/20/400
	800101	6A 2 way Switch	1	88	1/20/100
	800102	6A 1 way Switch with Indicator	1	86	1/20/200

SWITCHES 10A 230 V AC

HSN Code: 8536

	Cat. Nos.	Description	Module	Unit Price (₹)	Pack
	800114	10A 1 way Switch	1	42	1/20/400
	800115	10A 2 way Switch	1	92	1/20/100
	800116	10A 1 way Switch with Indicator	1	90	1/20/200

SWITCHES 16A 230 V AC

HSN Code: 8536

	Cat. Nos.	Description	Module	Unit Price (₹)	Pack
	800103	16A 1 way Switch	1	110	1/20/200
	800104	16A 2 way Switch	1	150	1/10/100
	800105	16A 1 way Switch with Indicator	1	132	1/20/200

SWITCHES 20A 230 V AC

HSN Code: 8536

	Cat. Nos.	Description	Module	Unit Price (₹)	Pack
	800107	20A DP Switch with Indicator	2	192	1/10/50

SWITCHES 25A 230 V AC

HSN Code: 8536

	Cat. Nos.	Description	Module	Unit Price (₹)	Pack
	800106	25A 1 Way Switch with Indicator	1	200	1/10/100

SWITCHES 32A 230 V AC

HSN Code: 8536

	Cat. Nos.	Description	Module	Unit Price (₹)	Pack
	800108	32A DP Switch with Indicator	2	266	1/10/50

BELL PUSH BUTTON 6A 230 V AC

HSN Code: 8536

	Cat. Nos.	Description	Module	Unit Price (₹)	Pack
	800110	6A Bell Push with Indicator	1	98	1/20/200
	800111	6A Bell Push with Indicator	2	154	1/10/100

SOCKET 240 V AC • Child Safety Shutter • Smooth Plug removal & insertion

HSN Code: 8536

	Cat. Nos.	Description	Module	Unit Price (₹)	Pack
	802800	6A 3 pin Round Socket with Shutter (ISI mark)	2	92	1/20/200
	800122	6A/16A 3 pin Socket with Shutter (ISI mark)	2	182	1/10/50

ELVIRA
A SENSIBLE SWITCH

DIMMERS AND FAN REGULATORS • Laser Marking for Easy Identification

HSN Code: 8538 & 8414

	Cat. Nos.	Description	Module	Unit Price (₹)	Pack
	800143	Light Dimmer 400W	1	406	1/10/100
	800141	Fan 4 Step Regulator 100W (ISI mark)	1	384	1/10/100
	800142	Fan 4 Step Regulator 100W (ISI mark)	2	476	1/10/100
	800139	Fan 8 Step Regulator 100W	2	586	1/10/100

SKIRTING LIGHT

HSN Code: 8536

	Cat. Nos.	Description	Module	Unit Price (₹)	Pack
	800155	Skirting Light	2	410	1/5/25

INDICATOR

HSN Code: 8536

	Cat. Nos.	Description	Module	Unit Price (₹)	Pack
	800154	Flat Indicator Red	1	114	1/20/100

BUZZER

HSN Code: 8536

	Cat. Nos.	Description	Module	Unit Price (₹)	Pack
	800140	Buzzer 230V	1	290	1/20/100

BELL CALL INDICATOR

HSN Code: 8536

	Cat. Nos.	Description	Module	Unit Price (₹)	Pack
	800144	Bell Call Indicator	1	620	1/20/100

SOCKETS AND CONNECTORS

TV SOCKETS

HSN Code: 8536

	Cat. Nos.	Description	Module	Unit Price (₹)	Pack
	800132	TV Socket	1	100	1/20/100

DATA & VOICE

HSN Code: 8536

	Cat. Nos.	Description	Module	Unit Price (₹)	Pack
	800130	Telephone Socket - RJ11	1	102	1/20/100
	800131	Computer Socket - RJ45 Cat 6	1	258	1/20/100

ELVIRA
A SENSIBLE SWITCH

PROTECTORS AND ACCESSORIES
MOTOR STARTER

HSN Code: 8536

	Cat. Nos.	Description	Module	Unit Price (₹)	Pack
	800196	25A Motor Starter	2	472	1/10/50

MODULAR MCB (IS : 608981:2002) • Laser marking

HSN Code: 8536

	Cat. Nos.	Description	Module	Unit Price (₹)	Pack
	800160	16A Mini MCB SP C Curve	1	420	1/10/100
	800191	20A Mini MCB SP C Curve	1	420	1/10/100
	800156	25A Mini MCB SP C Curve	1	420	1/10/100
	800157	32A Mini MCB SP C Curve	1	420	1/10/100

PROTECTORS AND ACCESSORIES
POWER UNIT

HSN Code: 8536

	Cat. Nos.	Description	Module	Unit Price (₹)	Pack
	800193	Power Unit with 20A MCB & 16A Plug	3	992	1/10
	800194	Power Unit with 25A MCB & 16A Plug	3	1,066	1/10

ELECTRONIC FUNCTION

USB CHARGERS (IS13252 (PART 1) / IEC 60950-1) • CRS Certified

HSN Code: 8536

	Cat. Nos.	Description	Module	Unit Price (₹)	Pack
	800145	USB charger 1500mA Type A	1	926	1/10/100

HOSPITALITY FUNCTION
HOTEL KEYCARD SWITCH

HSN Code: 8538

	Cat. Nos.	Description	Module	Unit Price (₹)	Pack
	800197	Key card Switch 15A	2	2,366	1/1/10

HOTEL "DND AND MMR"

HSN Code: 8538

	Cat. Nos.	Description	Module	Unit Price (₹)	Pack
	800192	DND Internal Unit	2	204	1/10/100
	800195	DND External Unit	2	242	1/10/100

ACCESSORIES

HSN Code: 8538

	Cat. Nos.	Description	Module	Unit Price (₹)	Pack
	800151	1 Module Blank Plate	1	28	1/20/200
	800152	2 Module Blank Plate	2	48	1/10/100
	800153	Cable Outlet	1	82	1/20/100

ELVIRA
A SENSIBLE SWITCH

PLATE & FRAME

WHITE MODULAR PLATE WITH SUPPORT FRAME • Strong Dimensional Stability

HSN Code: 8538

	Cat. Nos.	Description	Module	Unit Price (₹)	Pack
	800161	White Plate + Frame 1M	1	86	1/10/100
	800162	White Plate + Frame 2M	2	86	1/10/100
	800163	White Plate + Frame 3M	3	118	1/10/100
	800164	White Plate + Frame 4M	4	134	1/10/100
	800166	White Plate + Frame 6M	6	174	1/10/100
	800167	White Plate + Frame 8M(Vertical)	8	242	1/5/25
	800168	White Plate + Frame 8M(Horizontal)	8	240	1/10/100
	800165	White Plate + Frame 12M	12	322	1/5/25
	800169	White Plate + Frame 16M	16	358	1/5/25
800170	White Plate + Frame 18M	18	432	1/5/25	

SILVER LIGHT PURPLE MODULAR PLATE WITH SUPPORT FRAME

HSN Code: 8538

	Cat. Nos.	Description	Module	Unit Price (₹)	Pack
	800201	Silver Light Purple Plate + Frame 1M	1	120	1/10/100
	800202	Silver Light Purple Plate + Frame 2M	2	120	1/10/100
	800203	Silver Light Purple Plate + Frame 3M	3	150	1/10/100
	800204	Silver Light Purple Plate + Frame 4M	4	186	1/10/100
	800205	Silver Light Purple Plate + Frame 6M	6	248	1/10/100
	800206	Silver Light Purple Plate + Frame 8M (Horizontal)	8	332	1/10/100
	800207	Silver Light Purple Plate + Frame 8M (Vertical)	8	332	1/5/25
	800208	Silver Light Purple Plate + Frame 12M	12	426	1/5/25
	800209	Silver Light Purple Plate + Frame 16M	16	560	1/5/25
	800210	Silver Light Purple Plate + Frame 18M	18	602	1/5/25

INOX SILVER MODULAR PLATE WITH SUPPORT FRAME

HSN Code: 8538

	Cat. Nos.	Description	Module	Unit Price (₹)	Pack
	800211	Inox Silver Plate + Frame 1M	1	120	1/10/100
	800212	Inox Silver Plate + Frame 2M	2	120	1/10/100
	800213	Inox Silver Plate + Frame 3M	3	150	1/10/100
	800214	Inox Silver Plate + Frame 4M	4	186	1/10/100
	800215	Inox Silver Plate + Frame 6M	6	248	1/10/100
	800216	Inox Silver Plate + Frame 8M (Horizontal)	8	332	1/10/100
	800217	Inox Silver Plate + Frame 8M (Vertical)	8	332	1/5/25
	800218	Inox Silver Plate + Frame 12M	12	426	1/5/25
	800219	Inox Silver Plate + Frame 16M	16	560	1/5/25
	800220	Inox Silver Plate + Frame 18M	18	602	1/5/25

ELVIRA
A SENSIBLE SWITCH

POLARIZED GREY MODULAR PLATE WITH SUPPORT FRAME

HSN Code: 8538

	Cat. Nos.	Description	Module	Unit Price (₹)	Pack
	800221	Polarized Grey Plate + Frame 1M	1	120	1/10/100
	800222	Polarized Grey Plate + Frame 2M	2	120	1/10/100
	800223	Polarized Grey Plate + Frame 3M	3	150	1/10/100
	800224	Polarized Grey Plate + Frame 4M	4	186	1/10/100
	800225	Polarized Grey Plate + Frame 6M	6	248	1/10/100
	800226	Polarized Grey Plate + Frame 8M (Horizontal)	8	332	1/10/100
	800227	Polarized Grey Plate + Frame 8M (Vertical)	8	332	1/5/25
	800228	Polarized Grey Plate + Frame 12M	12	426	1/5/25
	800229	Polarized Grey Plate + Frame 16M	16	560	1/5/25
800230	Polarized Grey Plate + Frame 18M	18	602	1/5/25	

ASH PURPLE MODULAR PLATE WITH SUPPORT FRAME

HSN Code: 8538

	Cat. Nos.	Description	Module	Unit Price (₹)	Pack
	800231	Ash Purple Plate + Frame 1M	1	120	1/10/100
	800232	Ash Purple Plate + Frame 2M	2	120	1/10/100
	800233	Ash Purple Plate + Frame 3M	3	150	1/10/100
	800234	Ash Purple Plate + Frame 4M	4	186	1/10/100
	800235	Ash Purple Plate + Frame 6M	6	248	1/10/100
	800236	Ash Purple Plate + Frame 8M (Horizontal)	8	332	1/10/100
	800237	Ash Purple Plate + Frame 8M (Vertical)	8	332	1/5/25
	800238	Ash Purple Plate + Frame 12M	12	426	1/5/25
	800239	Ash Purple Plate + Frame 16M	16	560	1/5/25
800240	Ash Purple Plate + Frame 18M	18	602	1/5/25	

METAL FLUSH BOX • Made of G.I. Sheet • Earth Terminal for Safety • Provision for Knockouts Available

HSN Code: 8538

	Cat. Nos.	Description	Module	Unit Price (₹)	Pack
	800172	Metal Flush Box 1/2 Module	1/2	70	40
	800173	Metal Flush Box 3 Module	3	90	40
	800174	Metal Flush Box 4 Module	4	106	40
	800176	Metal Flush Box 6 Module	6	160	20
	800177	Metal Flush Box 8 Module (Vertical)	8	206	20
	800178	Metal Flush Box 8 Module	8	206	20
	810867	Metal Flush Box 9 Module	9	246	20
	800175	Metal Flush Box 12 Module	12	270	10
	800179	Metal Flush Box 16 Module	16	310	10
800180	Metal Flush Box 18 Module	18	338	10	

PLASTIC SURFACE BOX • Flame Retardant Material • Edge to Edge Fitting with Plate • ISI Marked

HSN Code: 8538

	Cat. Nos.	Description	Module	Unit Price (₹)	Pack
	800182	Plastic Surface Box 1/2 Module	1/2	72	50
	800183	Plastic Surface Box 3 Module	3	90	35
	800184	Plastic Surface Box 4 Module	4	102	25
	800186	Plastic Surface Box 6 Module	6	156	10
	800187	Plastic Surface Box 8 Module (Vertical)	8	212	15
	800188	Plastic Surface Box 8 Module	8	212	10
	800185	Plastic Surface Box 12 Module	12	268	10
	800189	Plastic Surface Box 16 Module	16	312	10
	800190	Metal Surface Box 18 Module	18	348	10

Cover Plates - ELVIRA
A SENSIBLE SWITCH

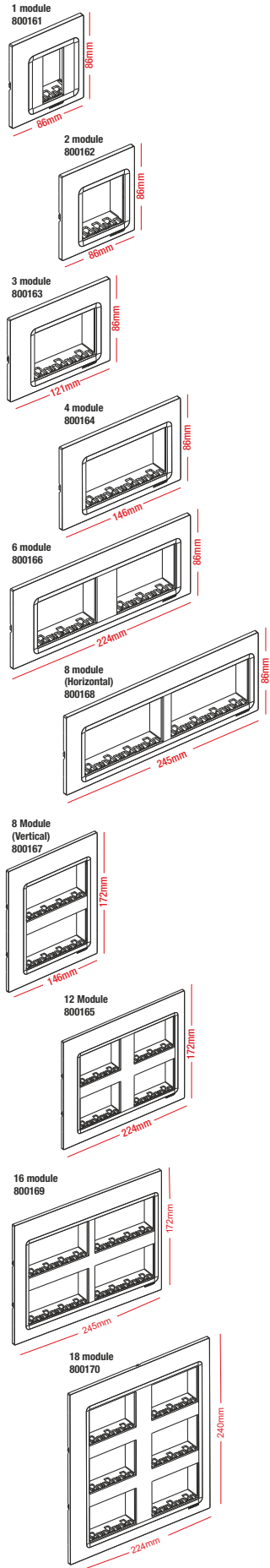

Flush Boxes-Metal

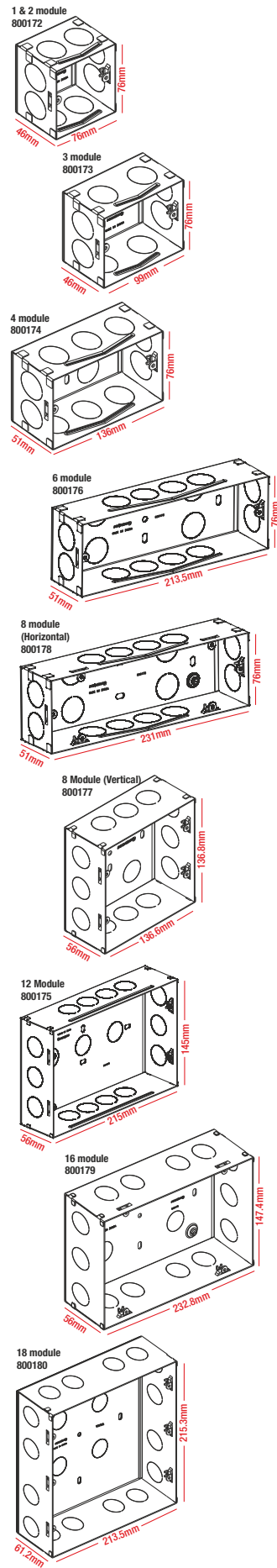

Surface Boxes-Plastic

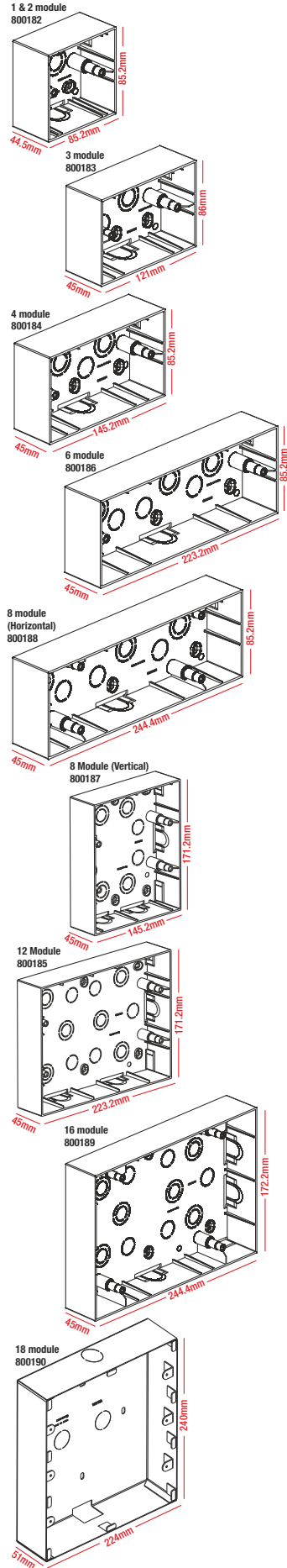



No More Waiting, Welcome!

Doorsta
DING DONG DOORBELL



BIS
COMPLIANT



ROHS
COMPLIANT



EASY
INSTALLATION



HIGH SOUND
OUTPUT



WORKS ON
240V AC



MADE IN
INDIA



A Range to Match Your Needs

ZostaTM
A POWERFUL
EXHAUST FAN



SILENT
OPERATION



EASY
INSTALLATION



ROHS
COMPLIANT



Doorsta (Ding Dong Doorbell) • High Sound Output • BIS / ROHS Compliant

HSN Code: 8536

	Cat. Nos.	Description	Unit Price (₹)	Pack
	698450	Doorsta Ding Dong Doorbell*	434	1/20
	698451	Doorsta Ding Dong Doorbell*	458	1/20

* Will be launched soon

3 PIN PLUGS WITH EASY GRIP • White Matt Finish • ISI Marked

HSN Code: 8536

	Cat. Nos.	Description	Unit Price (₹)	Pack
	698470	6A 3 Pin Plug (ISI mark)	100	20/200
	698471	16A 3 Pin Plug (ISI mark)	148	10/100

FANCY BATTEN BULB HOLDER / CEILING ROSE • Dynamic Design • Metal Ring Avoids Deformation

HSN Code: 8536

	Cat. Nos.	Description	Unit Price (₹)	Pack
	698473	Fancy Batten Bulb Holder White (ISI mark)	82	20/200
	698474	Fancy Angle Bulb Holder White (ISI mark)	82	20/200
	698475	Fancy Ceiling Rose White	54	20/200

Zosta™ EXHAUST FAN - WHITE / BLACK • Copper Motor • ROHS Compliant • Rust Free Body

HSN Code: 8536

	Cat. Nos.	Description	Unit Price (₹)	Pack
	698500	Exhaust Fan 150mm White	2216	1/6
	698501	Exhaust Fan 200mm White	2484	1/6
	698502	Exhaust Fan 250mm White	2836	1/6
	698503	Exhaust Fan 150mm Black	2216	1/6
	698504	Exhaust Fan 200mm Black	2484	1/6
	698505	Exhaust Fan 250mm Black	2836	1/6

AXIAL EXHAUST FAN - WHITE • Copper Motor • ROHS Compliant • Rust Free Body

HSN Code: 8536

	Cat. Nos.	Description	Unit Price (₹)	Pack
	698506	Axial Exhaust Fan 100mm White	1562	1/20
	698507	Axial Exhaust Fan 150mm White	1706	1/20



Bright Ideas For Happy & Safe Living!

**BULB HOLDER &
CEILING ROSE**



ERGONOMIC
DESIGN



ROHS
COMPLIANT



ISI MARKED



DUCTS FOR HEAT
DISSIPATION



BEST IN
CLASS QUALITY



METAL RING
AVOID DEFORMATION

GENERAL TERMS

- This price list supersedes all previous price lists.
- All prices are in Indian Rupees only.
- All prices are Maximum Retail Prices (MRP) inclusive of GST as applicable.
- Our discount structure is exclusive of GST
- Orders will be accepted in multiples of standard packing.
- Prices are subject to change without notice. All despatches will be as per prices prevailing on the date of despatch. Prices are ex-godown, exclusive of packing/forwarding/freight and insurance.
- Product design is subject to change without notice for continuous up gradation.
- Disputes if any are subject to Delhi Jurisdiction only.
- Company reserves the right to issue amendments which may arise due to any printing errors in the price list.

WARRANTY

IA products carry a warranty against manufacturing defects, subject to use of the product for the right application, with correct wiring/connection and normal operating conditions. Please refer to detailed IndoAsian warranty policy effective 1st Jan 2025.

MCBs	36 Months
RCCBs	36 Months
DBs/ACCL	12 Months
HRC Fuses	6 Months
MCCBs/BFF/Fuse Bases/Changeover Switchgears/SDF	12 Months
Time Switches	12 Months
For Wiring Devices - Switches & Socket	120 Months
Bulb Holder/Ceiling Rose	12 Months
For Wiring Devices - Electronic Products (e.g. Fan Regulator, Dimmer, Buzzer, RJ45, RJ11 & TV Sockets, Bell Indicator, Motor starter, Skirting light)	24 Months

CHANNEL PARTNER

CORPORATE OFFICE: V. J. Business Towers, A-6, 1st Floor, Sector-125, Noida-201301, U.P., India. Ph.: +91-0120-3305111 E-mail: customer.care@indoasian.com, international@indoasian.com Website: www.indoasian.com

CUSTOMER CARE HEAD: Novateur Electrical & Digital Systems Pvt. Ltd., V. J. Business Towers, A-6, 1st Floor, Sector-125, Noida-201301, U.P., India.
Ph.: +91-0120-3305100 Toll Free no. 1800 103 7077 E-mail: customer.care@indoasian.com

NORTH

Regional Sales office

DELHI NCR

V. J. Business Towers
A-6, Ground Floor,
Sector-125, Noida-201303
Ph.: 0120-6858900

Branch office

CHANDIGARH

SCO No. 6, 2nd Floor,
Madhya Marg, Sector 26,
Chandigarh-160019

Branch office

JAIPUR

433, 4th Floor, Ganpati Plaza,
M. I. Road,
Jaipur-302001
Ph.: 0141-4113528

Branch office

LUCKNOW

301, 3rd Floor, Chintel House,
Station Road,
Lucknow-226001
Ph.: 0522-4013210

SOUTH

Regional Sales office

BANGALORE

787, 1st Floor "Skyline Vista" 15th Cross,
100 Feet Ring Road, J P Nagar 1st Phase,
Bangalore-560 078
Tel: 080-46219999
E-Mail: in-bangalore-office@indoasian.com

Branch office

COCHIN

Door No.65/1317, Syda Building, 2nd Floor,
Kaloor-Kadavanthra Road, Kaloor,
Ernakulam District, Kochi-682017 (Kerala)
Ph.: 0484-4055581-88
E-Mail: in-cochin-office@indoasian.com

Branch office

COIMBATORE

Door No. 83,
Dr. Nanjanpa Road,
Coimbatore-641018
Ph.: 0422-2302715
E-Mail: in-coimbatore-office@indoasian.com

Branch office

CHENNAI

No.5, 1st Floor, Mahalingapuram Main Road,
Nungambakkam,
Chennai-600034
Ph.: 044-28172096, 28170527
E-Mail: in-chennai-office@indoasian.com

Branch office

HYDERABAD

312, 3rd Floor,
Amrutha Estates, Himayath Nagar,
Hyderabad-500029
Ph.: 040-66742425
E-Mail: in-secunderabad-office@indoasian.com

WEST

Regional Sales office

MUMBAI

401 & 408, K.P. Arrum,
Marol Maroshi Road, Andheri East,
Mumbai-400059
Ph.: 022-61035800
E-Mail: in-mumbai-office@indoasian.com

Branch office

AHMEDABAD

102, 1st Floor, Shivalik High Street,
Near Mansi Circle, Vastrapur,
Ahmedabad-380015
Ph.: 079-29701351-53
E-Mail: in-ahmedabad-office@indoasian.com

Branch office

INDORE

Tower B, 403 - The One
Ravindra Nath Tagore Marg,
Indore- 452001
Ph.: 0731-4677510
E-Mail: in-indore-office@indoasian.com

Branch office

PUNE

311, Pride Silicon Plaza, Bhamburda,
Shivaji Nagar, Senapati Bapat Marg,
Pune-411016
Ph.: 8087610722
E-Mail: in-pune-office@indoasian.com

EAST

Regional Sales office

KOLKATA

"Raikva Building" Room No. 8, 2nd Floor,
3A Ram Mohan Garden Lane, Beliaghata E.M.Bypass,
Kolkata-700010
Ph.: 033-66041503
E-Mail: in-kolkata-office@indoasian.com

IA/Price List/04-25

INDOASIAN
MAKES SENSE

WESUPPORT

E-mail: customer.care@indoasian.com

INDOASIAN
MAKES SENSE